

YUNEEC H520 OWNERS GUIDE

V1.3.1(a)

Owners Guide

UNBOXING THE H520

Thank you for purchasing the Yuneec H520 Commercial Series Unmanned Aerial Aircraft. The H520 has advanced features to assist with commercial, cinematography and other aerial needs. The H520 has a variety of camera systems ranging from UHD 4K, to 50mm equivalent, to Thermal/Low Light sensors with more to come. This H520 comes equipped with the ST16S Ground Station, an intuitive remote controller which features a 7-inch Android touchscreen multifunction display that shows live footage of in-flight video, telemetry and aircraft location within a planned mission flight area.

This guide provides information on setting up, usage of, and safety parameters for the Yuneec H520. Please be certain to download the Maintenance Guide from commercial.yuneec.com

UNFOLDING THE ARMS

Once the H520 has been removed from the storage/transport case, lock the arms in place. Gently lift the arms until a click is heard. Test the locks by gently lifting up and pressing down on the arms several times. To unlock the arms, press the PRESS button on the base of the arms. On new systems, it may be necessary to release the arms while lifting up on the bottom of the motor with one hand and pressing the Press button with the other. Doing so relieves some of the pressure on the locking system.

Note: Do not depress the PRESS button on the arms while unfolding and locking them into place; doing so may cause the arms to not engage the locking system.

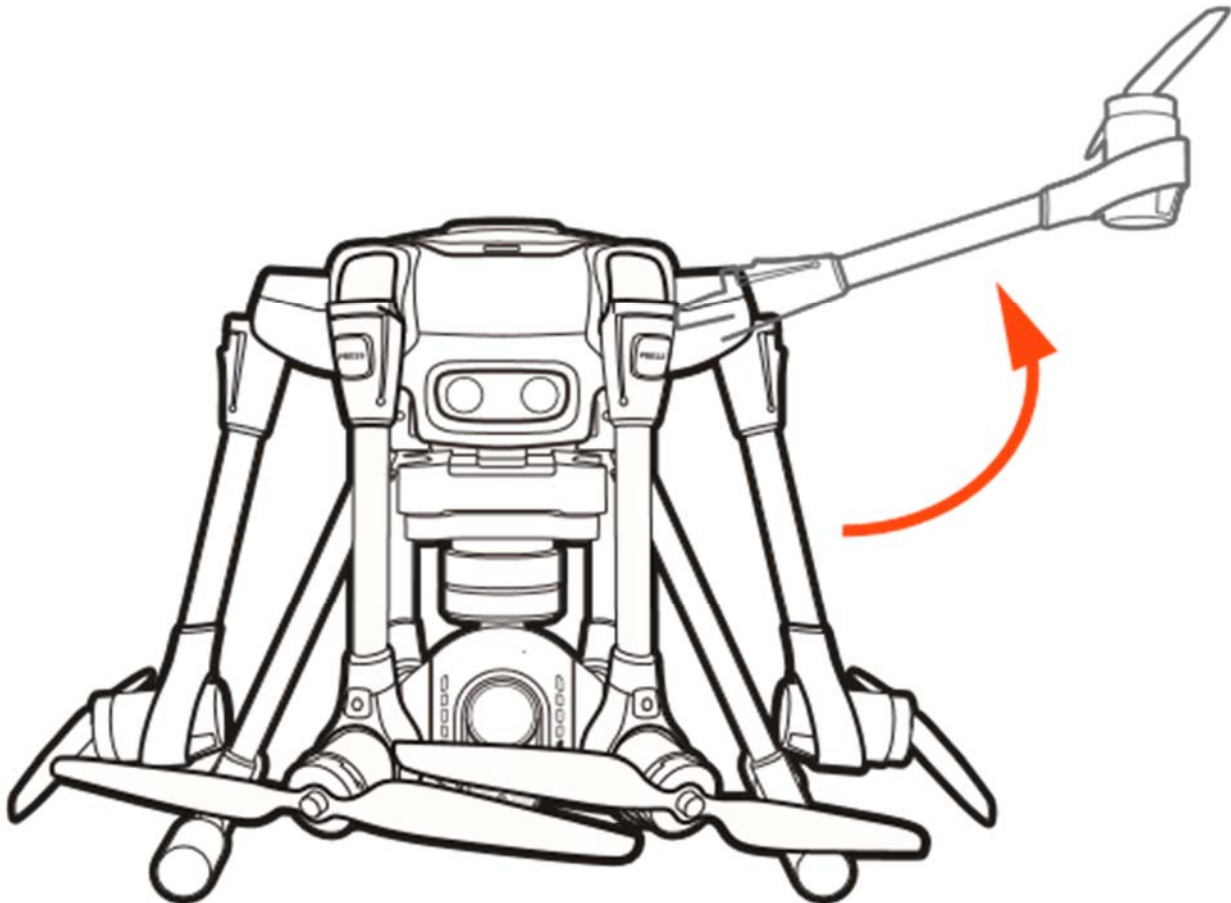

SELECTING A CAMERA

CAMERA SELECTIONS

Yuneec has several different camera/payload devices for use on the H520.

E90

Yuneec's E90 camera is a one-inch lens with seven CCDs to capture high quality images with 4k 10 bit in-camera color processing. Images may be captured in 20MB formats of JPEG or 40MB DNG format, or simultaneous capture of both formats. Video may be recorded in UHD, 2K, or HD resolutions at a variety of framerates. See the DataPilot™ section of this manual for more information.

E50

The E50 camera is a 39MM equivalent camera capable of recording video in 4k. Using a 39MM equivalent lens allows the H520 to operate farther away from the objective and still allowing object to be within optical range.

CGOET

CGOET is an innovative combination of 3-axis gimbal, thermal imaging camera and low-light camera. While the thermal imaging camera selectively measures the temperature in the image enabling it to display relative temperature differences, the low-light RGB camera has a 20 times higher sensitivity than the human eye and can still take excellent shots even in low light conditions. Both images are streamed live on the remote control at the same time, and can be viewed separately as a picture-in-picture or as an overlay.

Highlights of the CGOET camera system:

- Thermal imaging camera and 1080p low-light camera combinable and recordable (picture in-picture or overlay)
- Temperature measurement and display
- Heat sources are well visualized thanks to the different color spectrums available
- Sliding temperature detection scale allows users to focus on the relevant areas
- Dual-stream recording allows for separate editing of thermal and RGB video or photo information

SD CARD SELECTION

Yuneec recommend using a SDXC Class 10 UHS-3 micro SD card for recording 4k video. Using the UHS-3 card allows the camera buffer to record to the micro SD card faster resulting in less buffer overrun.

INSTALLING THE CAMERA GIMBAL

Select a camera (E50, E90 or CGOET), remove the protective cover, install a micro SD Card in the rear of the camera, and mount the camera on the H-Mount. Using the arrow on top of the camera gimbal pointed towards the H520, slide the camera gimbal (arrow towards the airframe) until the front latch clicks. Gently pull the camera gimbal away from the aircraft to check proper installation, if the gimbal comes off the rail or is not solid and secure, remove the gimbal and install the gimbal again.

Note: Ensure both rails on the H-Mount are seated. Do not press the gimbal past the stopping point, this will result in damage to the six connecting pins and mounting system. If the installed camera gimbal does not appear to be powering up (flashing led light on the front of the camera), remove the camera and check the pin connectors on both the gimbal and H-Mount.

CHANGING THE CAMERA GIMBAL

Power down the H520 using the power button on the top of the airframe, press the camera latch on the front of the camera mount and slide the camera gimbal of the mount. Select the preferred camera gimbal for use. Using the arrows on top of the camera gimbal, slide the camera onto the mount until the camera stops. Test the gimbal to ensure the camera is installed. Power on the H520 using the power button on top of the airframe. Lubricating these slides with graphite occasionally will keep them sliding smoothly.



Important Note: When changing cameras, the new camera will require re-linking through DataPilot™ using the below instructions.

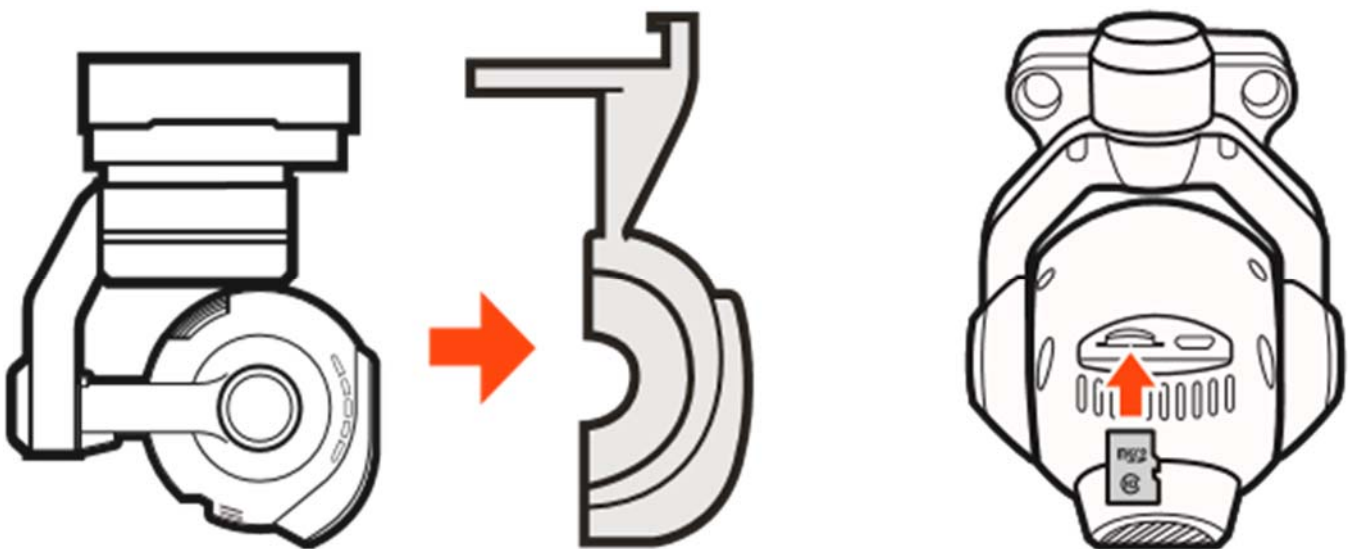

ST16S OVERVIEW

- 01 Start/Emergency Stop Motors Button
- 02 Gimbal Pan Mode
(Follow Mode/Follow Pan Controllable Mode/Global Mode) (Switch 2)
- 03 Gimbal Tilt Mode
(Angle Mode/ Velocity Mode) (Switch 1)
- 04 Gimbal Pan Control
- 05 Rudder/Yaw Control
(Mode 2 and Mode 1)
- 06 Throttle/Altitude Control (Mode 2)
Elevator/pitch control (Mode 1)
- 07 Take Still Photo Button
- 08 Landing Gear Switch
- 09 Sonar Obstacle Avoidance Switch (Switch 3)
- 10 Flight Mode Selection Switch
(Manual, Angle and Return to Launch (RTL) Flight Modes)(Switch 4)
- 11 Aileron/Roll Control (Mode 2 and Mode 1)
- 12 Elevator/Pitch Control (Mode 2)
- 13 Start/Stop Video Recording Button
- 14 Power Switch
- 15 Mushroom Antenna (5.8 GHz)
- 16 Antenna (2.4 GHz)
- 17 Proportional Control Rate Slider (Turtle and Rabbit Mode)
- 18 Gimbal Tilt Control Slider
- 19 Battery

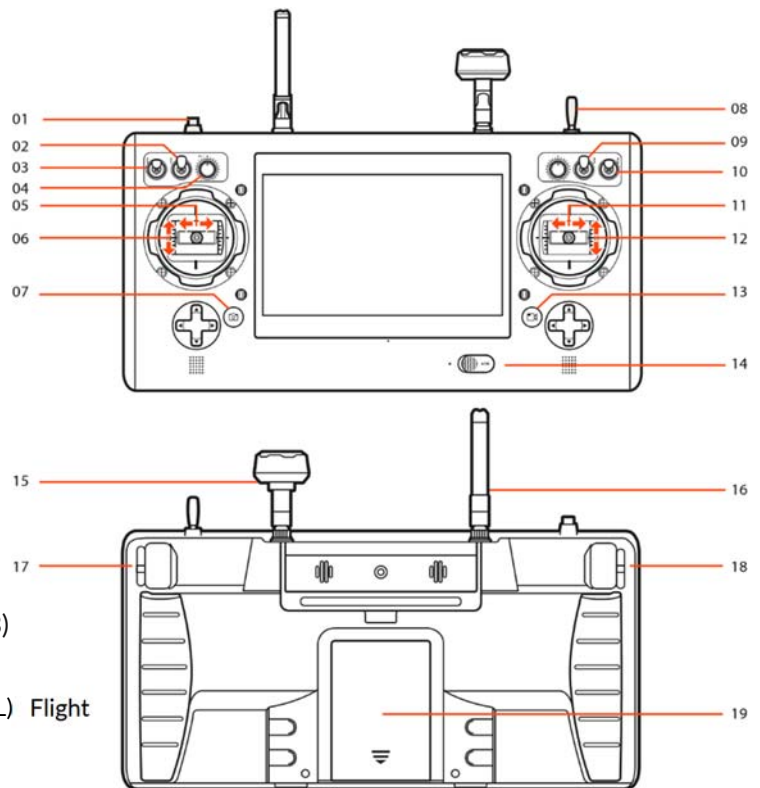

Note: Switches on the front of the ST16S are labeled with S1, S2, S3, and S4.

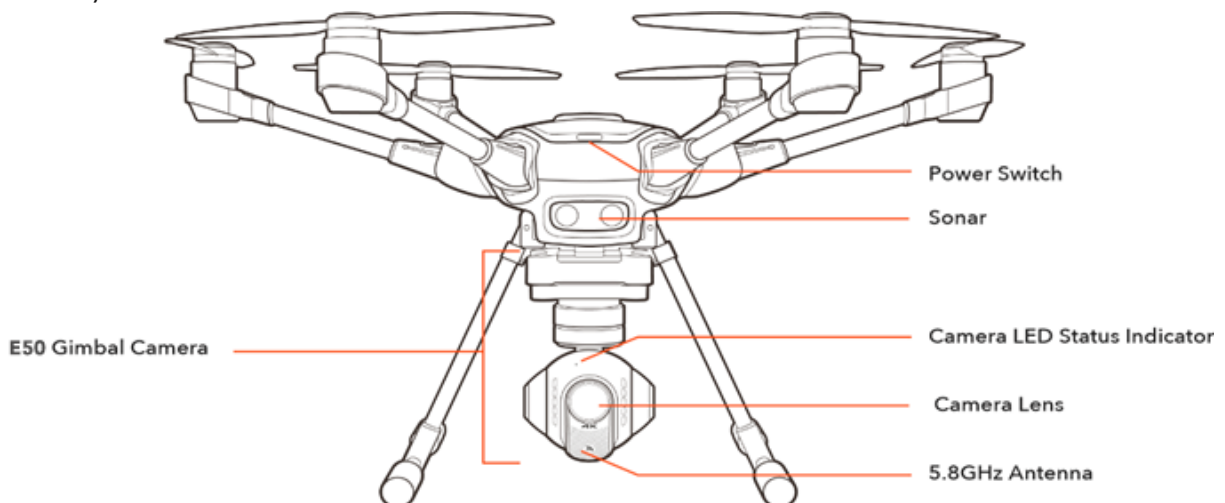

CHARGING

Power the desktop charger from a 100-240V AC outlet using the AC adapter/power supply, or from a 12V-16.8V DC accessory socket/cigarette lighter receptacle in an automobile using the included adapter. Plug the aircraft battery into the charger port as illustrated.

A green blinking LED indicates the charger is powered on and ready to charge, and a red blinking LED indicates the battery is charging. It will take approximately 2.5 hours to charge a fully discharged (not over-discharged) battery. A solid green LED indicates the battery is fully charged. Alternating red and green led lights indicate balanced charging (this ensures the individual cells inside the battery are charged to similar amounts).

Be certain to never completely drain an H520 battery. Batteries should be stored at 30-50% charge, and never stored at full charge.

*** Ask your dealer about the DY5 multi-charger for the H520 battery; with two charging docks, charging batteries is more than twice as fast, and the DY5 is capable of discharging batteries, preparing them for storage.*

WARNING

All instructions and warnings must be followed exactly to prevent property damage and/or serious injury as the mishandling of Li-ion/LiPo batteries can result in a fire.

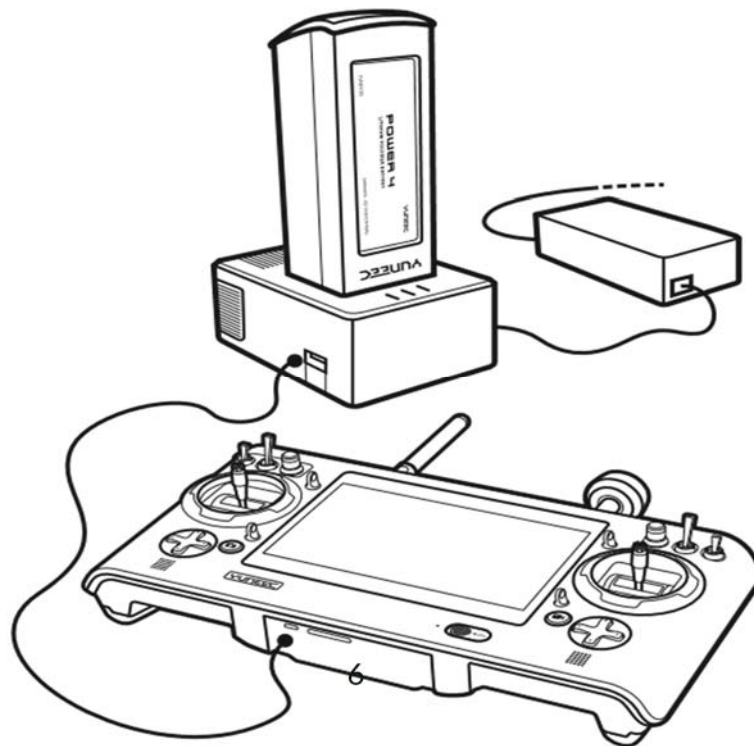

ST16S GROUND STATION: Charge the ST16S battery by using supplied USB cable and inserting it into the USB port on the charger. It will take approximately five hours to charge a fully discharged battery.

WARNING

Do not leave the battery in the charger after the battery is fully charged.

POWERING ON THE ST16S CONTROLLER

Power on the ST16S Controller by sliding the switch at the bottom of the ST16S to the left. A blue light will illuminate next to the switch and a “YUNEEC” splash screen will appear. DataPilot™ will automatically start, and the DataPilot™ Home screen will display.

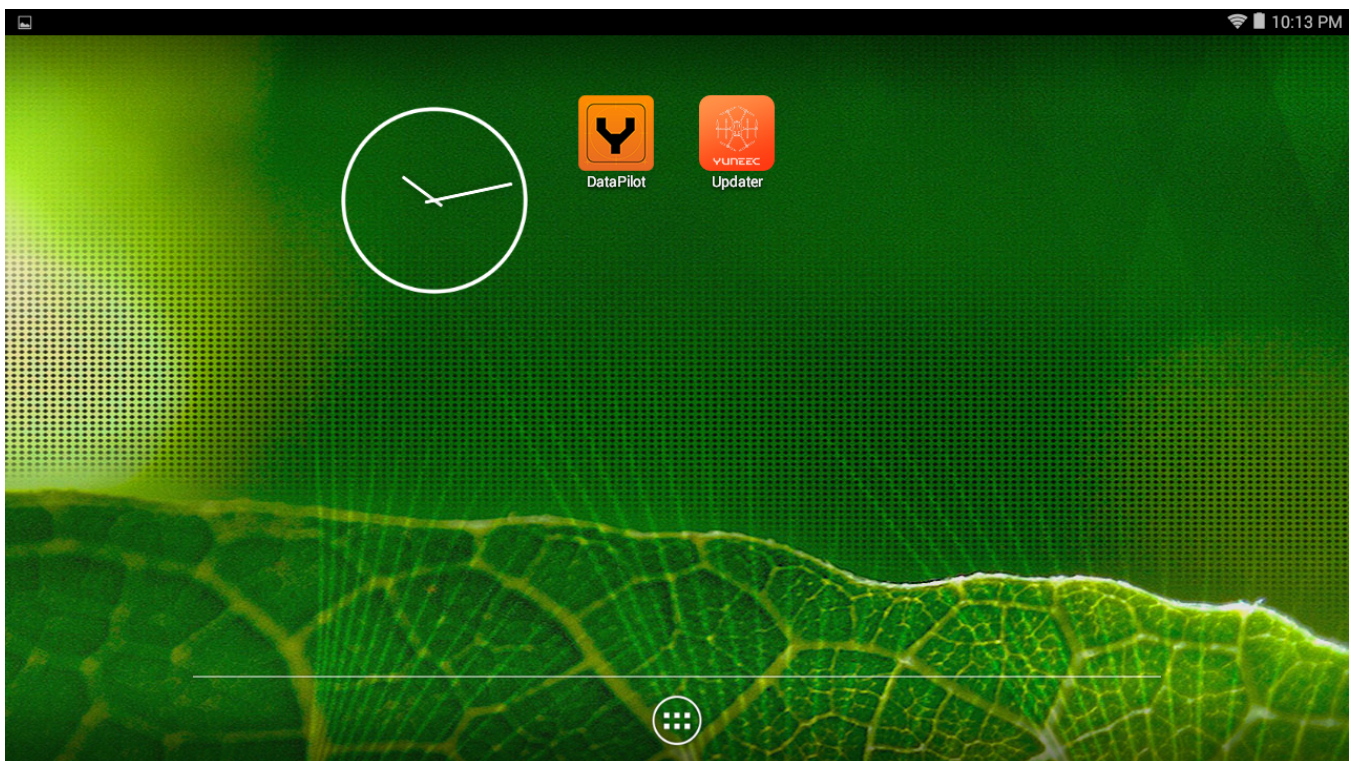
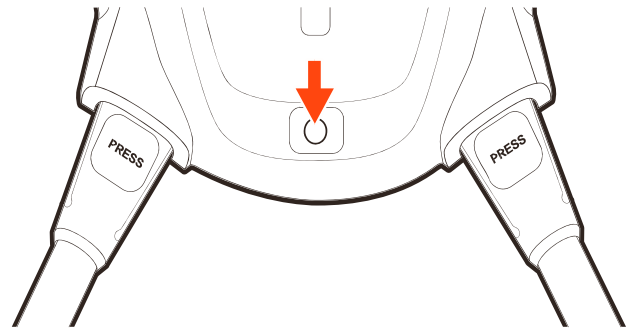
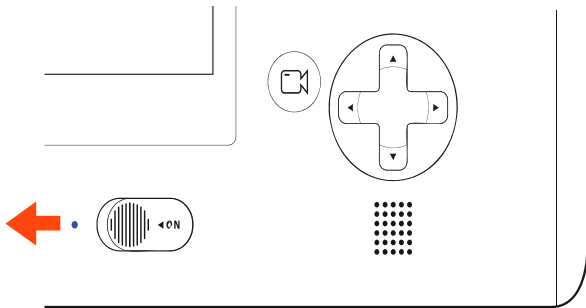

Note: ALWAYS turn on the ST16S Ground Station and allow it to boot up **BEFORE** turning the H520 on.

After flights - **ALWAYS** turn the H520 off **BEFORE** turning off the ST16S Ground Station).

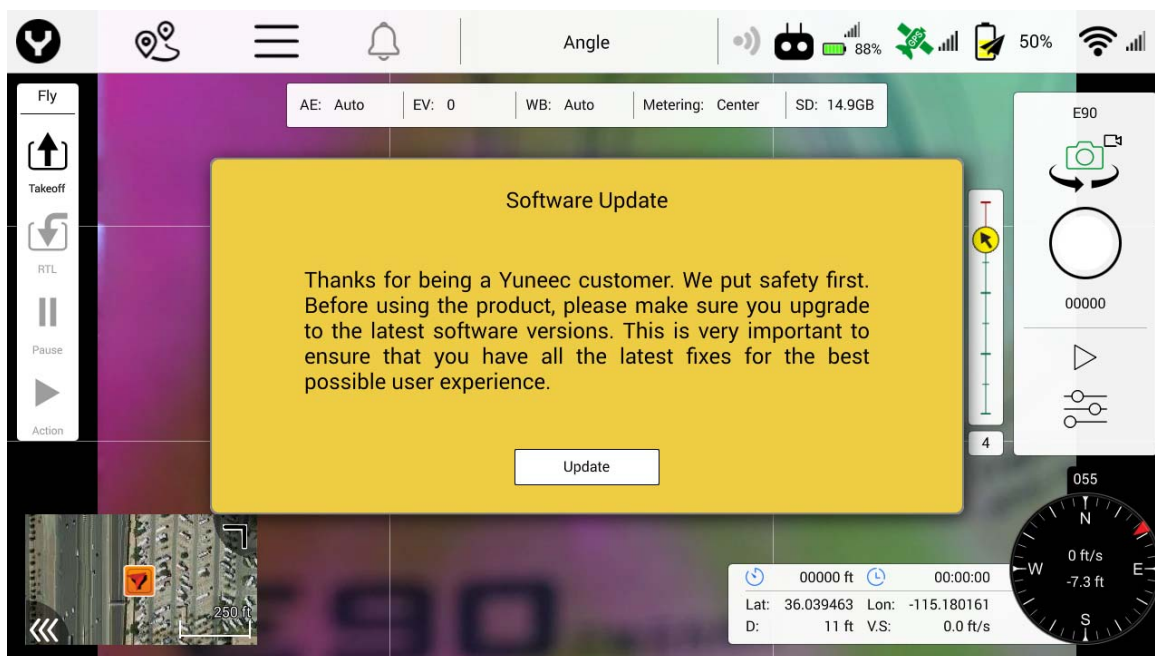

Selecting the Update soft button will open up the Yuneec UpdatePilot application and users will be asked to if they'd like to register the H520 system. We highly recommend registering to best remain informed about Yuneec updates, opportunities, and product announcements. Registration data is securely stored on local servers. Yuneec will never share registration data with any third party.

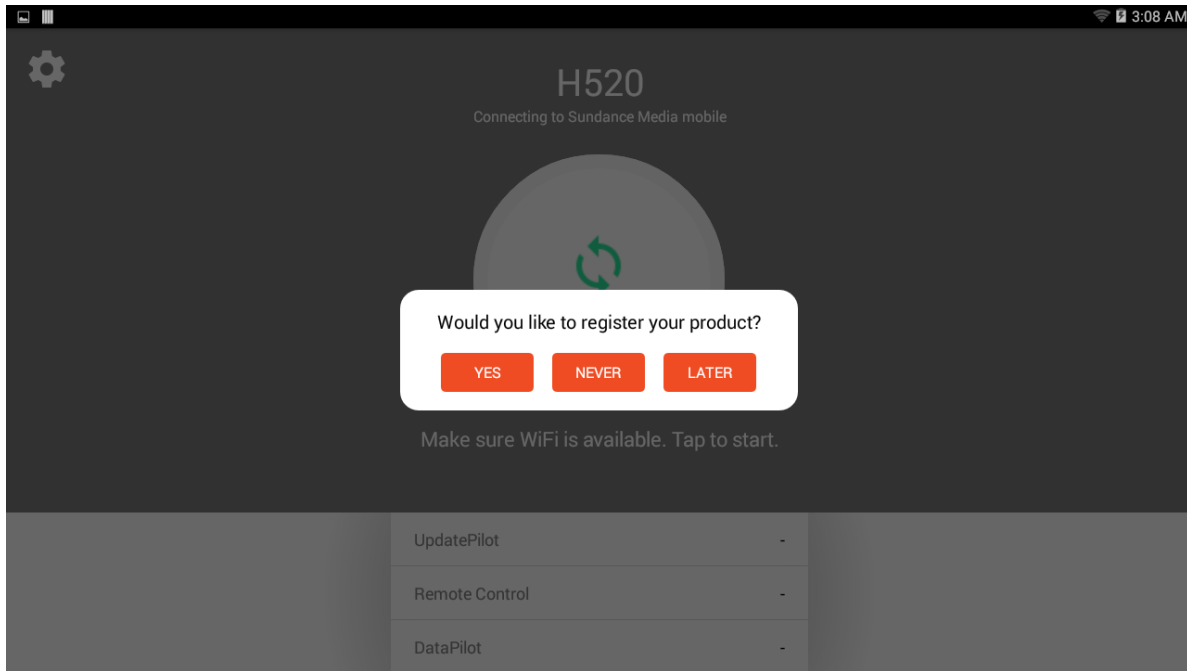

POWERING ON THE H520

After registering, power on the H520 first by inserting a battery with the YUNEEC logo on the rear facing up, gently push the battery into the rear of the H520 while lifting the rear lever on the back of the battery pack. Push the battery all the way in and release the lever, give one final push on the rear of the battery to ensure the battery is fully seated, a click will be heard as the lock engages. Ensure the battery is fully seated and latched before proceeding. Press and hold the power button (approximately two seconds) on the top of the airframe near the nose. Wait for the rising tone and arm lights to turn on, release the button. During start up the camera will rotate to the front of the airframe and several tones will announce the aircraft's readiness.

Note: Do not install the propellers until a Compass and Accelerometer Calibration have been completed. During these two calibrations, the airframe will be moved around and set on the ground. Having the propellers installed may cause damage to the props, motors, or arms, or may cause minor physical injury to the user.

CONNECTING THE ST16S AND H520

After the H520 has fully powered on, tap on the WiFi logo on the right side of the screen. Tap Link Management, available cameras will appear in the window. Tap on the desired camera to connect the ST16S and camera. Tap close.



- General
- Offline Maps
- Vehicle**
- Summary

Connected to Vehicle

Reset All Links

Select Vehicle to Connect 

 E90_310070

Note: If a camera does not appear, tap the arrow symbol or tap the 'Reset Link' button.

Note: If the Aircraft requires a password and the password has not been changed use:
1234567890.

Note: DataPilot™ may return to the map/camera screen. if this occurs, tap the Settings Menu icon again.

Note: Once the aircraft connects to DataPilot™ the Sensors, Safety and Gimbal menus will appear.

CALIBRATING THE COMPASS AND ACCELEROMETER

COMPASS

In the Settings Menu, tap Sensors | Compass. Follow the onscreen display and instructions. During Compass calibration, the H520 will need to rotate Counter-clockwise until a tone is heard and the display turns green. Repeat this procedure for all six positions. If Compass calibration fails, ensure there are no electronic devices or metal objects/areas within ten feet of the H520. A yellow box with a green arrow indicates the current calibration. A green box indicates a completed position.

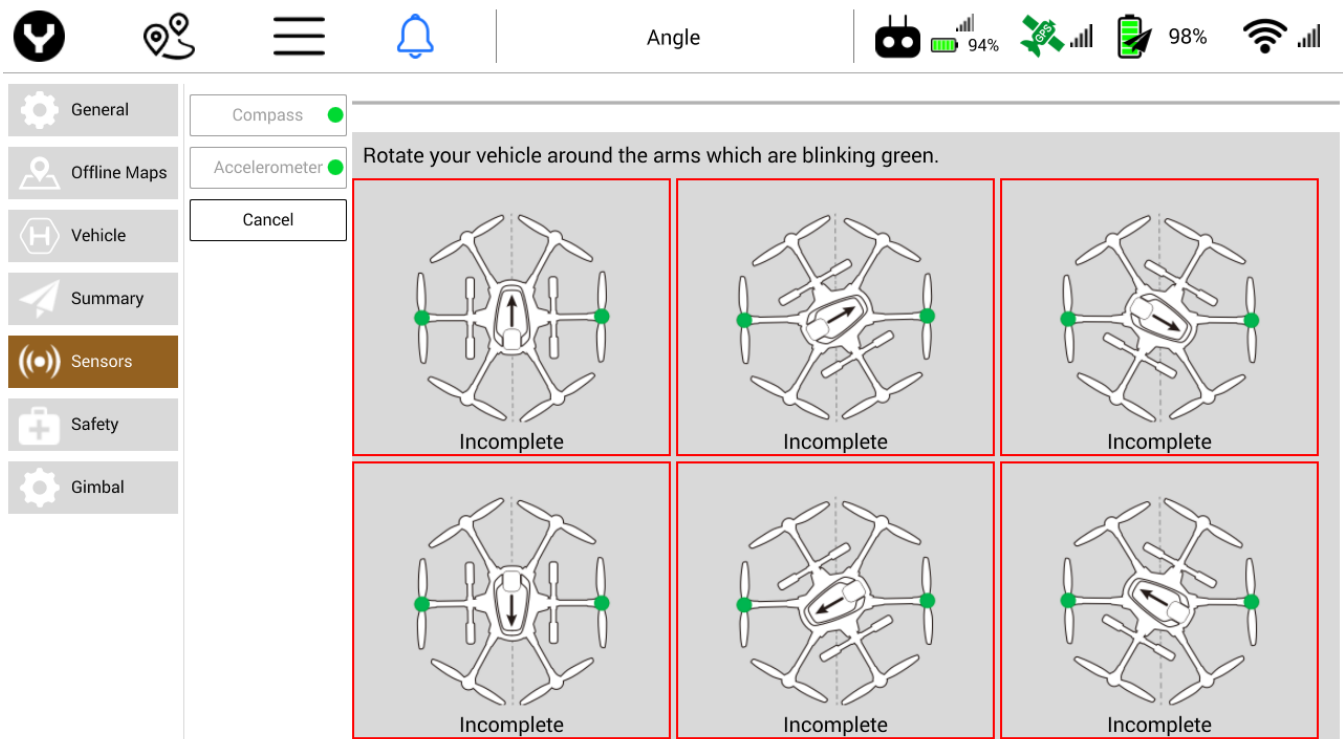

Note: If all six led lights flash Red rapidly, the Compass calibration has failed. Restart the procedure. If the issue persists, move the H520 to a different location.



Important Note: Recalibrate the Compass anytime the H520 aircraft has moved more than five miles from the last Compass calibration. Recalibrating allows for magnetic differences to be calculated prior to launch.

ACCELEROMETER

In the Settings Menu, select Sensors | Accelerometer. Follow the onscreen display and instructions. During Accelerometer calibration, aircraft must be set on *level ground* as instructed.

When placing the aircraft on level ground, the aircraft does not need to be at a 90-degree angle and may be rested against the arms and/or landing gear. Place the aircraft in the position as shown on the display. Do not move the aircraft until instructed by the ST16S.

These positions can be conducted out of order. Each box will turn yellow to indicate which position has been detected. A green box indicates the position has been calibrated. Once all six positions have been calibrated place aircraft upright.

Note: Removing the propellers prior to calibration will assist in preventing damage to the propellers, motors and the pilot's arms.

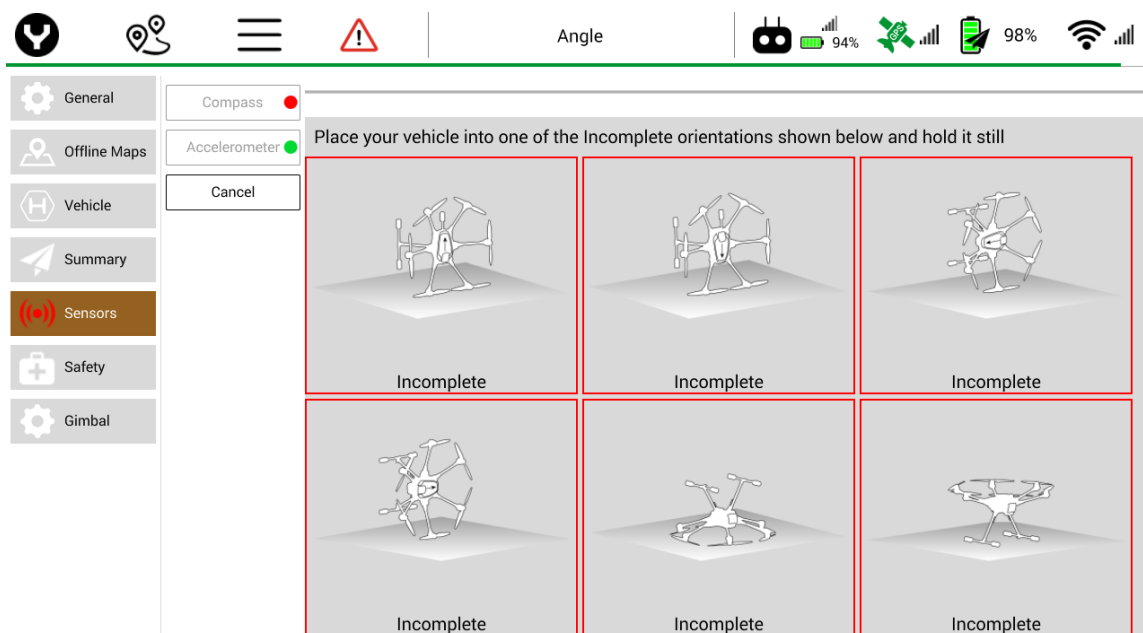

Note: After calibration press the  icon to return to the map/camera menu.

INSTALLING THE PROPELLERS

Each arm of the H520 has a letter A or letter B labeled on it. “A” arms have **black center** buttons; “B” arms have **white center** buttons.

Each propeller has an A or B label etched into the blade. “A” propellers cannot be attached to “B” motors, nor can “B” motors be mounted to an “A” motor.

Match the A propellers with the A arms (black center button) and the B propellers with the B arms (white center button). Place the prop on the motor, lightly press down and while holding the motor and turn the prop a quarter turn. A click will be heard and the center button will slightly pop up. Hold the motor and test propeller security to assure a locked propeller.

Note: H blades will fit on the H520 motors. However, **DO NOT** attempt to fly the H520 with H blades installed.

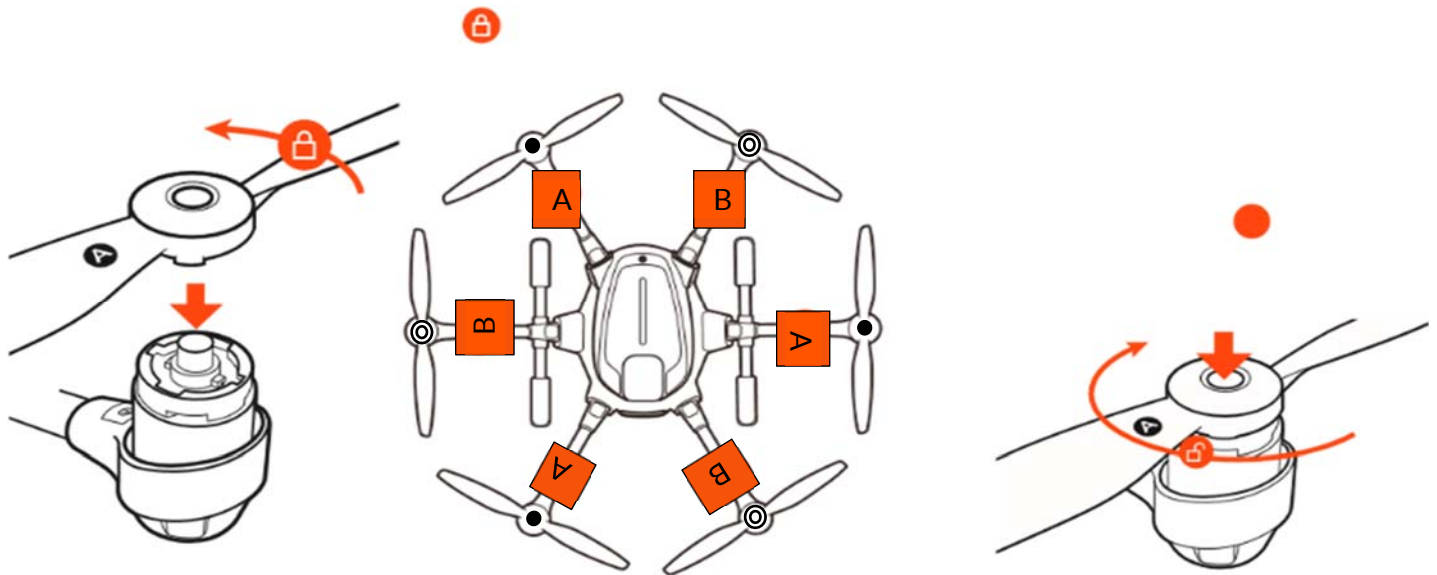

Important Note: Always check the props for damage and rough edges. Damaged props may cause in flight vibrations causing unwanted flight characteristics. Propellers should be replaced every 20 hours (see Maintenance Guide)



MOTOR START AND LAUNCH

Prior to motor start, position the H520 with the **nose pointing away** and the battery latch facing rearward (toward Pilot). It is highly recommended to start operating the H520 in Angle Flight Mode (to enable Angle Flight Mode move the far-right switch [the Flight Mode Selector {Switch 4 on the right side of the controller}] to the center position), also it is advised to keep the Proportional Control Rate Slider (under the right side of the ST16S) in the downward (turtle/slow) position. Best industry practices suggest the nose of the aircraft face into the relative wind.



Important Note: Yuneec recommends the use of a launch/landing pad to prevent Foreign Object Damage (FOD) to the motors, and reduces dust and debris from striking the camera lens and gimbal system. This is of particular importance when flying in dirt or dusty environments.

To start the motors, ensure the launch area is clear of personnel and equipment. Press and hold for two seconds, the red button on top of the ST16S on the left corner near the antennas. The propellers will start to spin. Visually check for any irregularities in prop speeds, noise or vibrations.

Once the visual and auditory check have been performed, move the left control stick forward (away from the Pilot). Do not hesitate to add maximum throttle input (in turtle mode). The H520 will lift off the ground. When the H520 is approximately 15-20 feet in altitude, release the left throttle stick, the stick will center itself and the aircraft will hold its altitude.

This is a good time to check the flight control systems, Yuneec recommends checking pitch, yaw, roll and altitude **before each flight**.

To check pitch, push the right stick away from the pilot, the H520 will move away, pull the right stick towards and the H520 will move towards the Pilot.

Check the roll axis by moving the right stick right, the H520 will slide to the right, moving the right stick to the left will cause the H520 to slide left.

To check the yaw axis, move the left stick to the left, the H520 will rotate in a counter-clockwise spin. Move the left stick to the right and the H520 will rotate in a clockwise spin.

Once the surface controls have been checked, the H520 is ready for flight. Position the gear switch on the top right of the ST16S to UP and the gear will retract, moving the gear switch to the DOWN position will lower/extend the landing gear.



Important Note: When the H520 is not nose away from the Pilot/ST16S (*in Angle Flight Mode*), the control inputs will be in opposition to forward flight. It is imperative to know which way the H520 is facing before making any control inputs. New pilots should learn to control the aircraft as it faces them.

ANGLE, MANUAL AND HOME FLIGHT MODES

ANGLE FLIGHT MODE

When the Flight Mode Selector (Switch 4 on the right side of the controller) is in the middle position the H520 is in Angle Flight Mode. In Angle (Pilot) Mode, the H520 will move in the direction the control stick is pushed relative to the front/nose of the aircraft (and the 'angle' of movement is determined by how far the stick is pushed away from the center position). In Angle Flight mode, the rear LED lights will be Purple.

MANUAL FLIGHT MODE

When the Flight Mode Selector (Switch 4 on the right side of the controller) is in the full forward position, the H520 is in Manual Flight Mode. In Manual Mode, the H520 is not connect to the GPS system, the H520 will maintain altitude. Manual Mode is recommended for high Electro-Magnet interference (EMI) areas. In Manual flight modes, use caution as the aircraft will drift without GPS positioning. It is recommended to fly in slow/turtle modes when in Manual flight modes. In Manual Flight mode, the rear LED lights will be Blue.

CAUTION! The aircraft will drift without GPS positioning in Manual Flight Mode

RETURN TO HOME MODE

When the Flight Mode Selector (Switch 4 on the right side of the controller) is in the full down position the H520 is in Return to Home Mode. Activate Return to Home Mode to automatically fly/return the H520 to the home point and land. In Return to Home mode, the rear LED lights will be Yellow.

LANDING AND MOTOR SHUTDOWN

MANUAL LANDING

When ready to land, fly the H520 towards the launch/landing area. At an altitude of 12 ft/3.5M or higher, lower the landing gear using the switch on the top right of the ST16S, placing the switch in the DOWN position. Use the left altitude stick to slowly bring the H520 down towards the landing point (turning the H520 nose away from the Pilot makes landing more intuitive on the right stick controls). After the H520 touches down, continue to hold the throttle stick down, **until motors stop**.

Power off the H520 before powering of the ST16S.

Note: It is recommended to disable Obstacle sonar prior to landing. Move the OBS Avoid (Switch 3) to the **center** position to deactivate OBS Avoid.

RETURN TO HOME LANDING

If at any time the H520 has been lost from Line Of Sight (VLOS), move the Flight Mode Selector (Switch 4 on the right side of the controller) to the full down position (**HOME**). This will activate **RETURN TO HOME** Mode and the H520 will start an automatic return to the Launch point. Once visual contact is regained, the aircraft may be placed back to Angle mode. This feature is particularly useful if the H520 is visually lost in bright sunlight.

During **RETURN TO HOME** Mode the pilot may maneuver the H520 to assist in automatic landings. As the H520 nears the ground the pilot should refrain from adjusting the controls as the H520 may tip over when being maneuvered as the legs touch down. Return to Home Mode will cause an automatic landing; the pilot should be prepared to use the throttle stick to shut down the motors, although the aircraft is expected to disarm/shut down motors on its own.

Important Note: Using the landing gear switch, lower the gear prior to attempting to land, landing gear will not automatically deploy when manually landing the aircraft



Note: Use the General Settings Menu to set the Return to Home altitude, ensure the flight area is checked for hazards during prior to activating Return to Home Mode.

DATA PILOT™

DATAPILOT™ INITIAL STARTUP

Power on the ST16S using the slider switch on the lower right of the ST16S case. Tap the WiFi icon button on the top right corner of the DataPilot™ screen. Tap the Link Management button under the WiFi icon. Select the camera attached to the H520 (e.g. E90_123456). If required, the default password is **1234567890**.

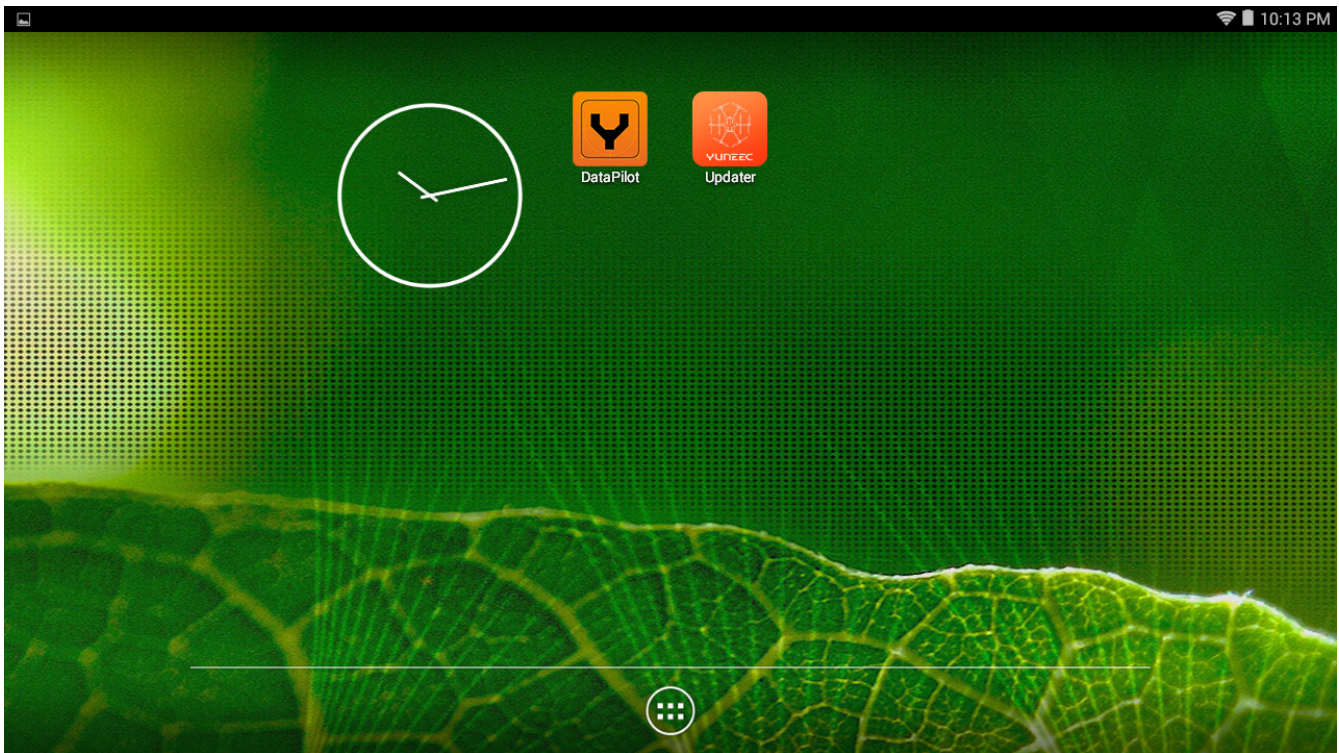

UPDATING SOFTWARE AND SETTING PASSWORDS

The first time the ST16S is turned on and DataPilot™ is launched, the ST16S will ask the user to set a system password, choose a color scheme (indoor/outdoor) and to choose Units of measurement (Metric/Imperial).

Either set a password of choice, or use a default of **1234567890** (default camera password). This may be changed at any time in the Settings menu.

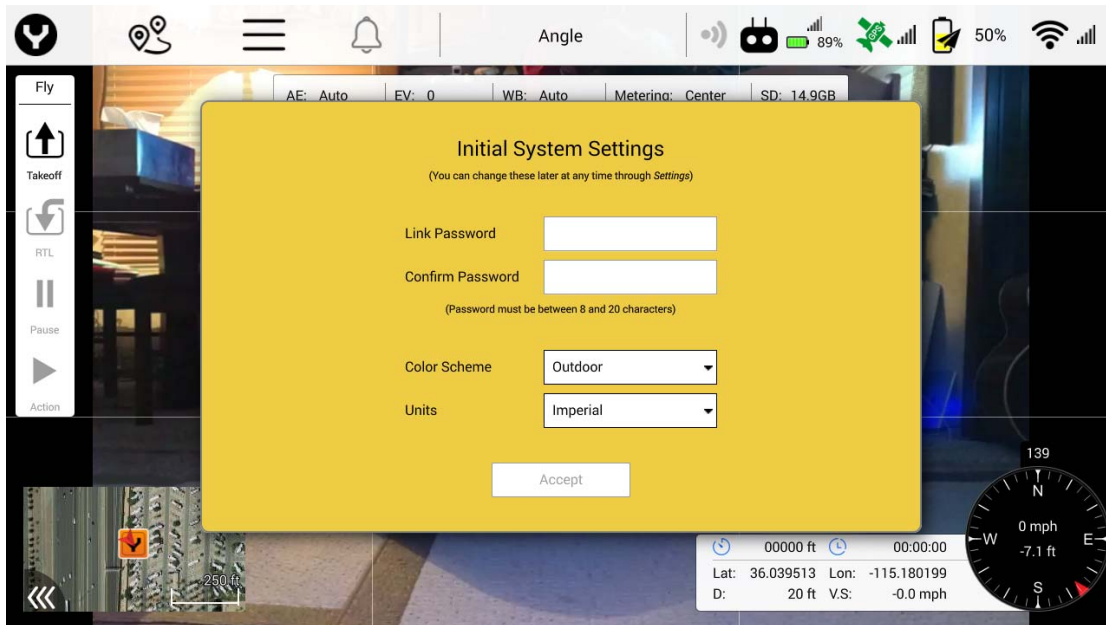

DataPilot™ will then ask about updating the software. The DataPilot™ may be updated without the aircraft being connected to the ST16S. However, the Autopilot, camera, and gimbal firmware require a connection to the ST16S. These components may be updated at any time after the H520 is connected to the ST16S by using the Yuneec Update Pilot application found on the home menu screen of the ST16S ground station controller.

Once the H520 is connected the ST16S will announce “Auto-Position Flight Mode” (ensure the ST16S volume is turned up via the – and + buttons on the bottom of the ST16S).

After the H520 fully connects to the ST16S, the application will announce “Auto-Position Flight Mode” and the top title bar will display “Angle” or “Manual” in the flight mode menu, depending on the current position of switch S4 (top right switch on ST16S).

Note: The first launch of the application will require a software update prior to the first flight.

HOME SCREEN SOFT KEYS

The  icon on the top left of the DataPilot™ screen will always return to the DataPilot™ Home Screen. Tap the Y once from any menu to return to the Home Screen. The Waypoint soft key navigates to the Waypoint planning screen (for more information on Waypoint planning refer to the [Waypoint](#) section of this manual).

The three-vertical line icon is the Main Menu button. The Main Menu contains settings for the ST16S, H520, and cameras (for more information on the Main Menu controls, refer to the [Main Menu](#) section of this manual).

The Bell icon or red Triangle icon displays messages between the H520 and ST16S. The blue bell indicates no errors have been transmitted and contains Start/Stop, Flight Log, and other telemetry data and messages. A red Triangle icon indicates an error has occurred. Tap the blue Bell/red Triangle button to view available messages.



The Flight Mode soft key enables the Pilot to change flight modes of the H520 between ANGLE and MANUAL flight modes (for more information on Flight Modes refer to the [Flight Mode](#) section of this manual).

The Controller icon enables the pilot to see the status of the ST16S including signal strength, ST16S battery, and ST16S GPS status.

The horizontal battery icon indicates the battery level of the ST16S.

The GPS Satellite soft key enables the Pilot to view the GPS status of the H520. A red Satellite icon indicates poor GPS signal. A yellow GPS Satellite icon indicates moderate GPS signal. A green GPS icon indicates a good GPS signal. Tapping the GPS soft key displays the aircraft's GPS Satellite count, GPS Lock status, HDOP status, VDOP status, and Course Over Ground status.

The vertical battery soft key with the paper airplane overlay is the current H520 battery status. Tapping the battery icon displays the H520 battery status in Volts and current Accumulated Consumption.

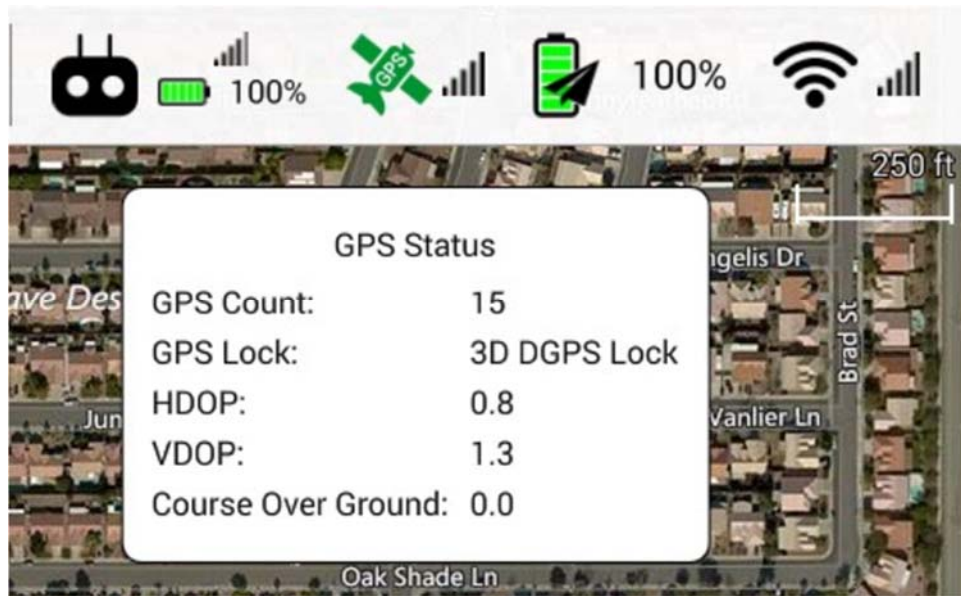

The WiFi soft key displays the current signal status between the ST16S and the H520.

- Tapping the WiFi soft key will display the current camera connected to the ST16S and the RSSI status in Db.
- Tapping the Link Management soft key will display other connectable cameras within WiFi range.
- Tapping the 'Reset All Links' will disconnect and reset all camera connections.
- Tapping the two arrow icon at the top of the Link Management window will cause the ST16S to search for cameras within range.

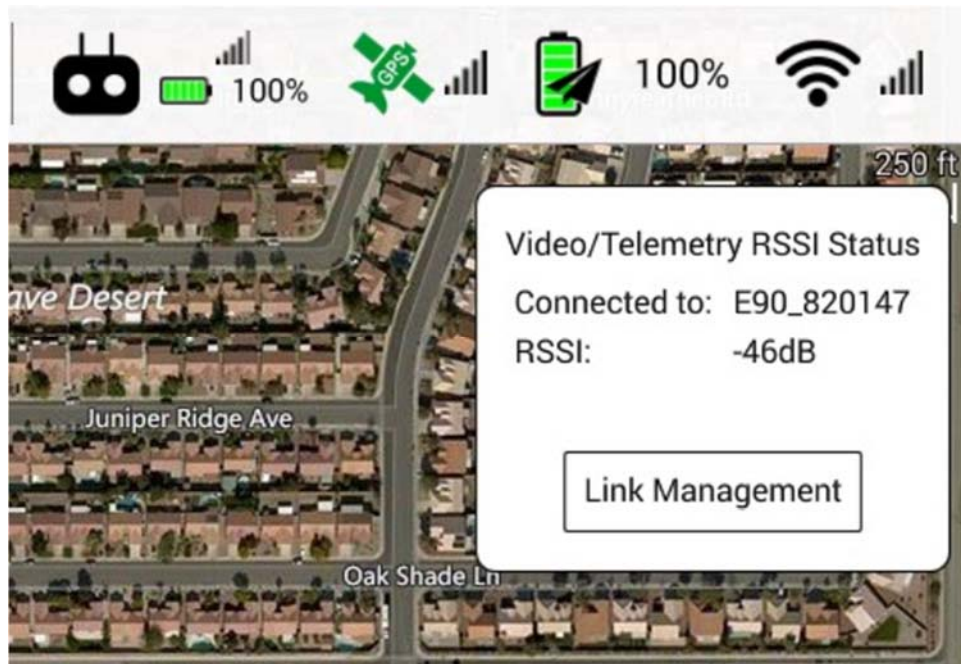

Note: The ST16S may only be connected to one camera at a time.

Note: Due to dynamic frequency selection (DFS) regulation in Europe, the camera may take up to 60 seconds to appear.



CAUTION: PRIOR TO LAUNCHING THE H520, it is required that all calibrations be performed. This is for safety and proper operation of the aircraft. See [Calibration section](#) for more information.

FLY MENU

To initiate an auto takeoff for the H520, ensure the takeoff area is clear of obstacles, personnel, and equipment. Tap the **Takeoff** soft key located to the left of DataPilot™ screen and the H520 will fly to the preset altitude (to preset an auto takeoff altitude refer to the [Main Menu](#) settings in this manual).

To auto land the H520, tap the **RTL** soft key -- the H520 will return to the takeoff location and land.

The **Pause** soft key will pause an active mission in Mission Mode (for more information on Mission Mode refer to the [Mission Mode](#) section of this manual).

The **Action** soft key will resume mission mode after the **Pause** soft key has been tapped.



FLIGHT TELEMETRY DISPLAY

Tapping the black dial will cause the white extension display drawer to collapse or expand. Tap the black dial again to extend the white display. This provides the ability to have greater viewing area on-screen, or to hide information that is unimportant to the mission.



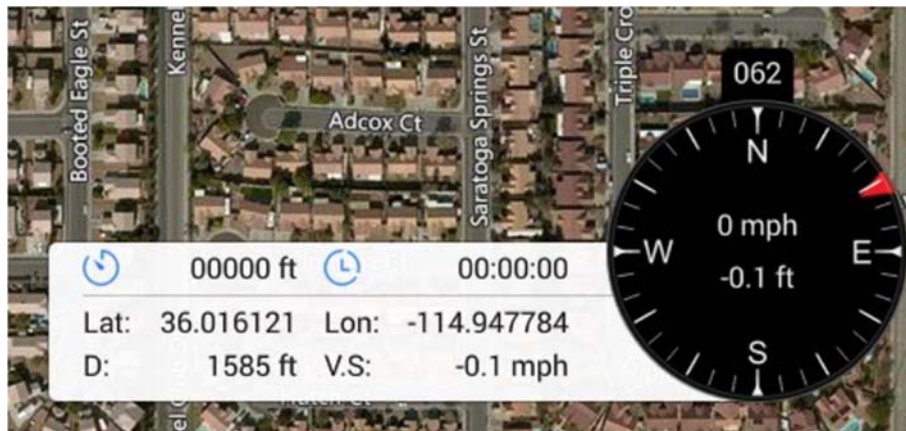

The Flight Telemetry Display on the lower right corner of the DataPilot™ Home Screen indicates:

- Black Compass
- Compass *heading* of the H520 (direction the nose of the aircraft is facing)
- Current *ground speed* of the H520
- Current *altitude* of the H520
- Left Extension
- Total flight distance
- Total flight time
- H520 Current Location (lat/long) - 'NO GPS' if no GPS lock
- H520 distance from ST16S - 'NO GPS' if no GPS lock
- H520 Vertical Speed

Airspeed is the delta/difference between the ground speed and wind speed. On a perfectly calm day with no wind, airspeed is equal to ground speed. If the wind is blowing in the same direction that the aircraft is moving (tail wind), the airspeed will be less than the ground speed. If the wind is blowing towards the aircraft (headwind), airspeed will be greater than ground speed.

TIP! If immediate log information is needed for sharing, the display may be screen-captured with current compass bearing, Lat/Lon, etc by pressing and holding the Screenshot icon for three seconds, found at the center bottom of the multi-function display. Images are stored in the Pictures/Screenshot folder on the ST16S. These images may be emailed directly from the ST16S (if connected to WIFI), downloaded to a card, or stored off to a thumbdrive.

MAP AND CAMERA VIEW

To toggle between the full screen Map and full screen live camera view, tap the rectangle box on the lower left of the DataPilot™ Home Screen. Depending on the current screen displayed, the Pilot will see a small map or a small camera rectangle in the lower left. To switch displays, tap the rectangle once.

The fullscreen view is valuable during photographic missions, while the Mission/Map view are vital during survey or waypoint missions. The two screens may be alternatively tapped at any time during any flight.

Double-tapping the display enlarges the view to full-screen, hiding all telemetry indicators and view controls. Tapping the display again restores the telemetry/controls to view.



The lower left view (camera or map) may be closed by tapping on the lower left layer icon in the lower left window. When closed, the window may be re-opened by tapping the icon in the lower left of the DataPilot™ screen.

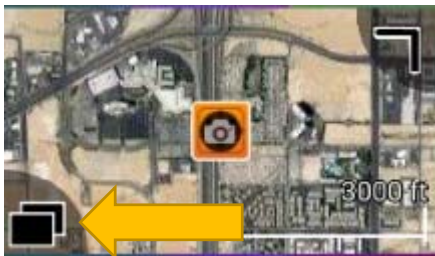

Views may be enlarged by tap/holding the indicator at the top right of the video preview, and dragged to desired size.

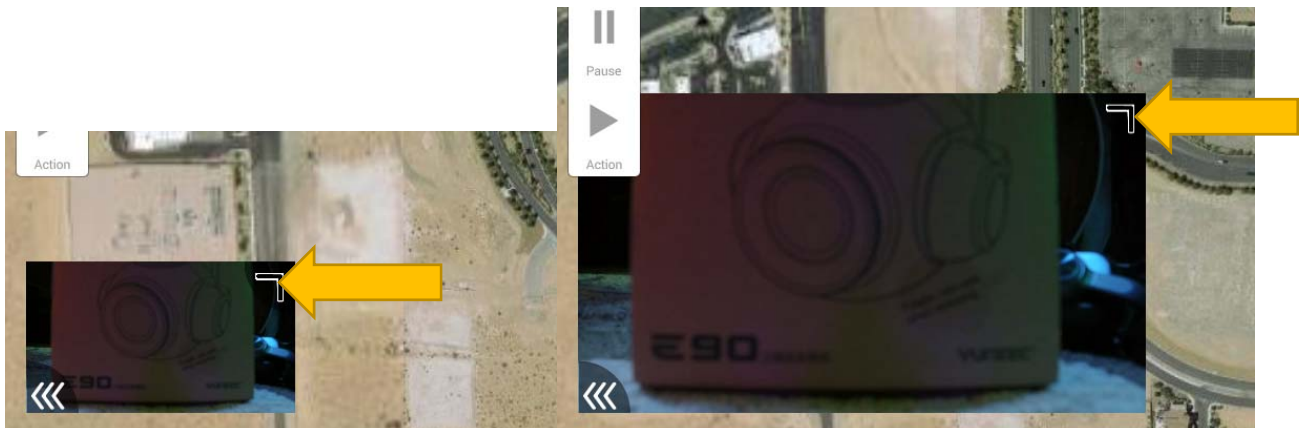

OBS INDICATOR

When the Obstacle Avoidance System (OBS) is activated, the H520 uses the two sonar sensors (sender and receiver units on the front of the H520) to detect and avoid forward collisions with objects. OBS will limit the forward speed to 4 m/s of the H520 to ensure the highest probability of avoiding a forward collision. There are three states of the OBS using switch S3 on the top left of the ST16S.

Using switch S3 on the ST16S, the Pilot can toggle the Obstacle Avoidance System (OBS). When Switch S3 is in the top position the OBS is set to off. When switch S3 is in the center position the OBS is in standby mode. When switch S3 is in the full down position, OBS is active.

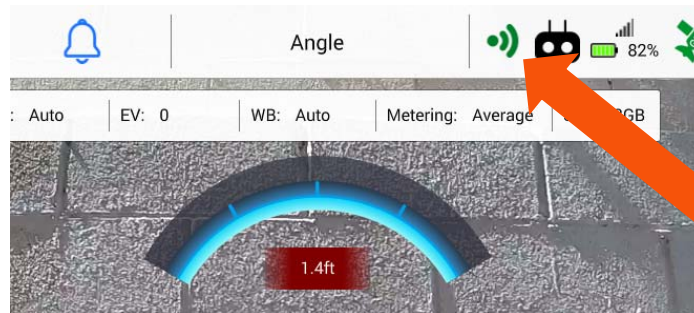

Obstacle Avoidance System (OBS) is enabled

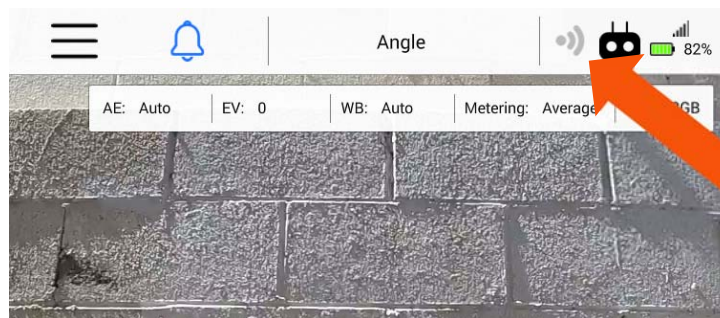

Obstacle Avoidance System (OBS) is disabled

Note: It is recommended to disable Obstacle sonar prior to launching or landing. Move the OBS Avoid (Switch 3) to the **center** position to deactivate OBS Avoid.

HDMI OUTPUT

Connecting the rear HDMI connector to an external distribution system allows users to view the information displayed on the ST16S screen on any external monitor such as those found in an Incident Command center, Command/Control, or a production video village.

This means that any display connected to the HDMI port will show identical information, making it efficient to share screen data on external screens.

Double-tapping the screen while in video view will hide control displays, providing a full-screen video display on both ST16S and external monitors.

CAMERA CONTROL PANEL

The Camera control panel is visible when connected to a camera in Camera View. This is used to change camera settings by the Pilot or Video operator. The Camera control panel displays the current type of camera connected to the ST16S and H520.

To access Camera settings, tap the video display window in the lower left corner of DataPilot™.

Tapping the Camera/Video soft key will change the camera mode. In camera mode, tapping the shutter button will take one image per tap. In video mode, tapping the red record button will begin recording video. Once recording begins, the record button will change to a red square button followed by an audible beep, and the recording time will update automatically below. To stop video recording, tap the red square button.

The Play soft key will open a file browser to view images saved on the internal ST16 memory. Images are saved by pressing the ST16 take photo button or by tapping the shutter button in Camera mode.

PREVIEWING VIDEO OR IMAGES ON THE ST16S

Recorded Photo and video images may be previewed directly on the ST16S. Selecting the “Play” soft button in the camera will open up a dialog of images and photos captured during flights. This preview is low-resolution for localized viewing, while also acting as a low-resolution, redundant backup system.

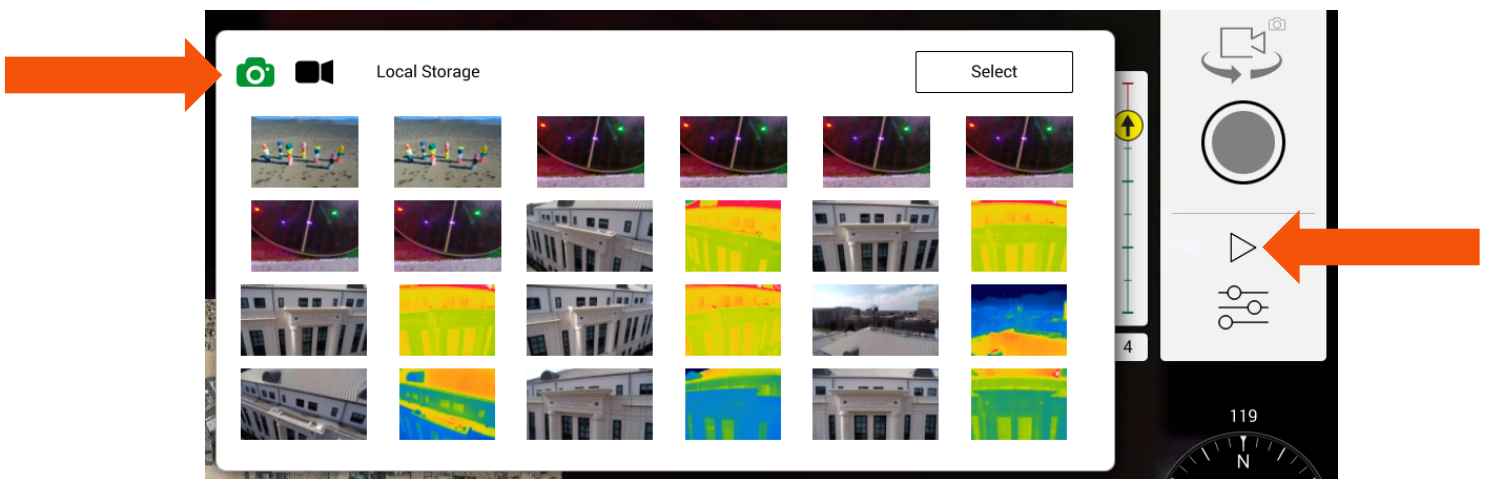

In this dialog, either photos or video may be selected. Selecting a video will auto-start playback of that video (video thumbnails are not supported at this time). Video files are stored in .mkv file format.

Video files are stored in the **ST16S Internal Storage | DataPilot | Videos** folders at a resolution of 1280 x 720, using the same framerate as determined in the Camera Menu.

During playback of video on the ST16S, tapping the video will pause the video. Tapping the video playback screen again will restart the video playback.

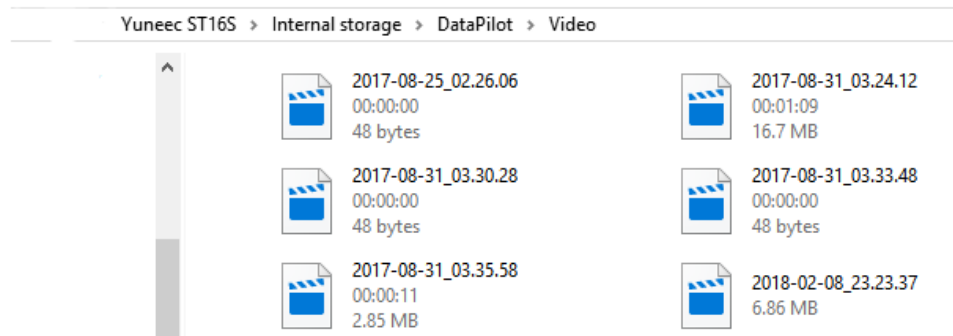

Photos are stored in the **Internal Storage | DataPilot | Photos** folder. Images are stored at a resolution of 1080 x 720/72dpi.

Outside of DataPilot™, these videos and images may be accessed in the ST16S tablet/Gallery application by navigating to the relevant file storage folders.

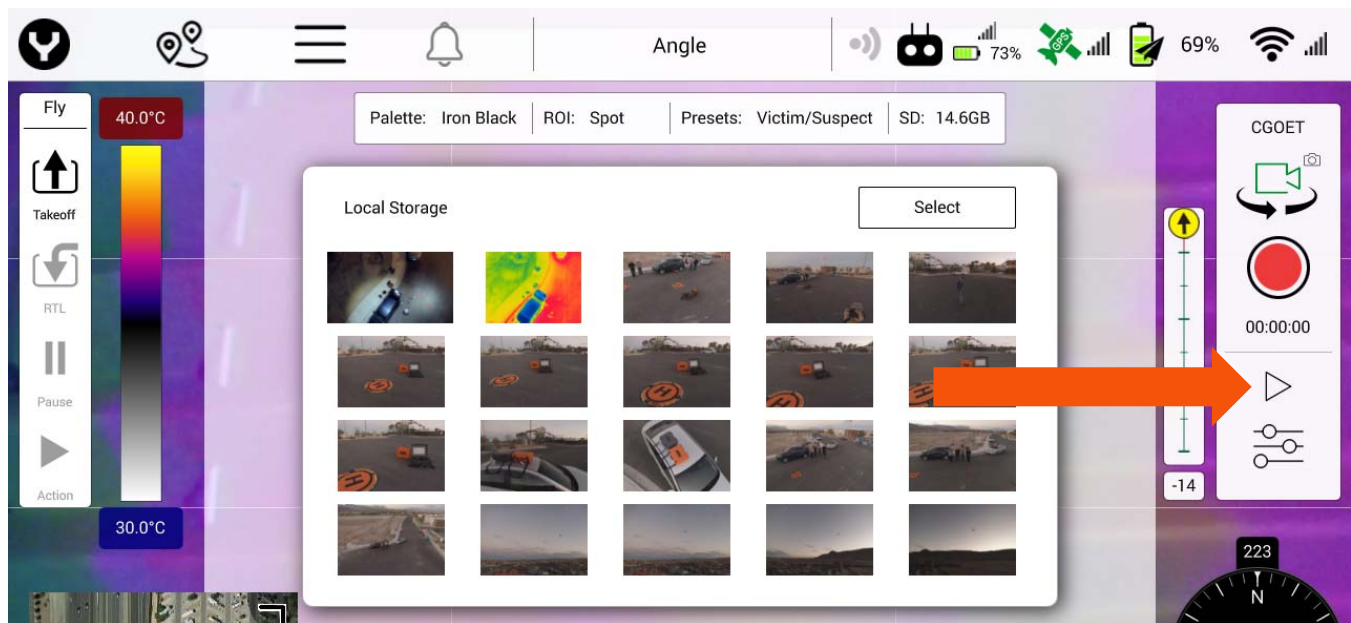

This feature enables photographers to check the frame composition of their image so that if necessary, the position of the H520 or camera angle may be adjusted in real-time.

Video Playback during a flight is not recommended.

However, in the event of pilot error where the aircraft is lost from sight and an incident occurs, the video may be played back on the ST16S to assist in locating the aircraft. The media playback feature also serves as a backup file in the event of a MicroSD card failure.

Camera Settings Menu

If there is no MicroSD card inserted to the camera, the camera mode may not be changed and only limited adjustments are possible within the camera Settings menu. DataPilot™ will notify/remind the pilot when there is no Micro SD card inserted to the camera.



Open the Camera Setting Menu by tapping the slider icon on the camera menu. Once open, the Camera Setting Menu controls Still and Video image recording and picture profile settings.

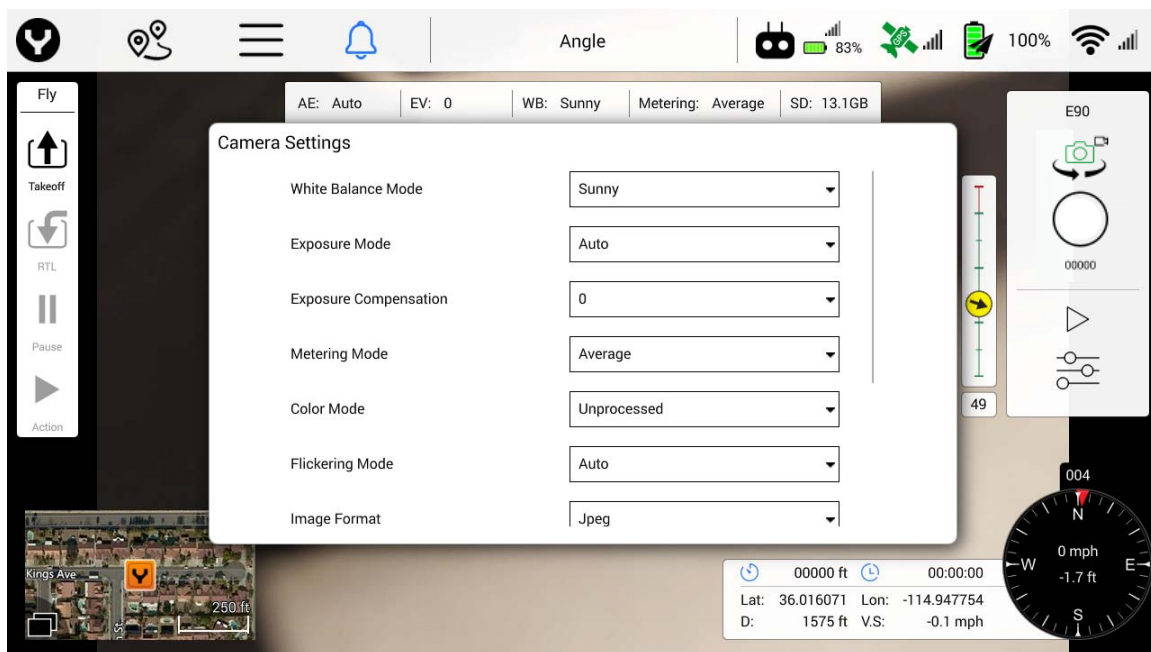

Still Camera Mode

Tapping the Camera Settings soft key in Still Camera Mode will only allow the Pilot/Video Operator to manipulate the following settings: White Balance Mode, Exposure Mode, Exposure Compression, Metering Mode, Color Mode, Image Format, Image Quality, and Screen Grid.

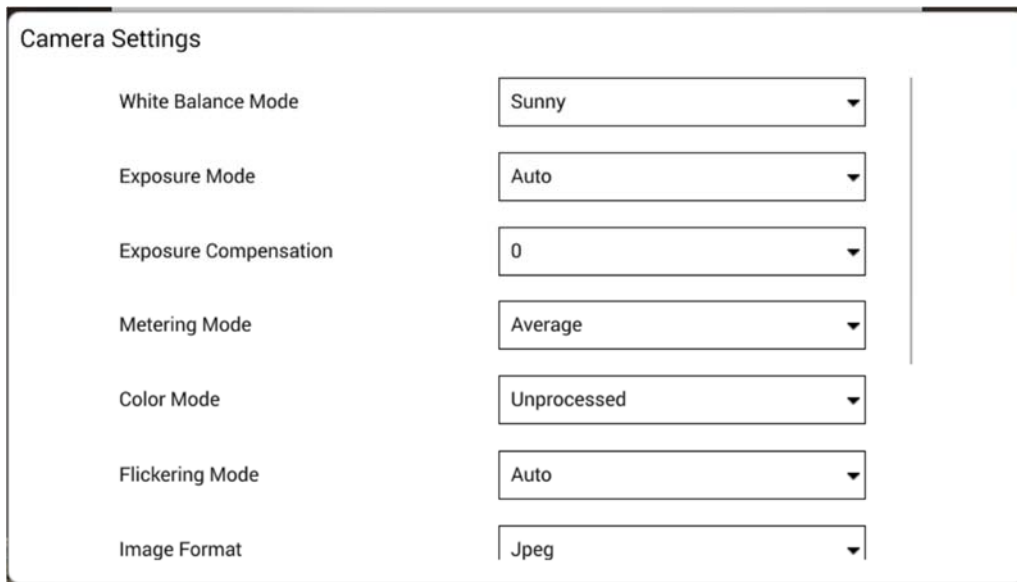
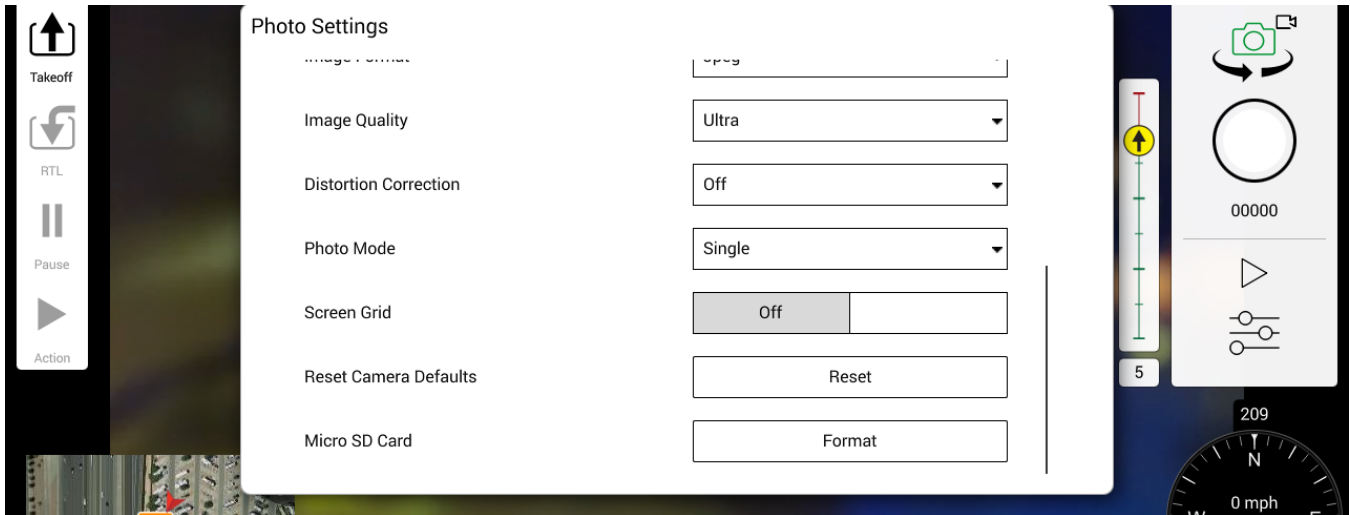

Disabling Auto Exposure setting will enable the Pilot/Video Operator to change ISO and Shutter Speed.

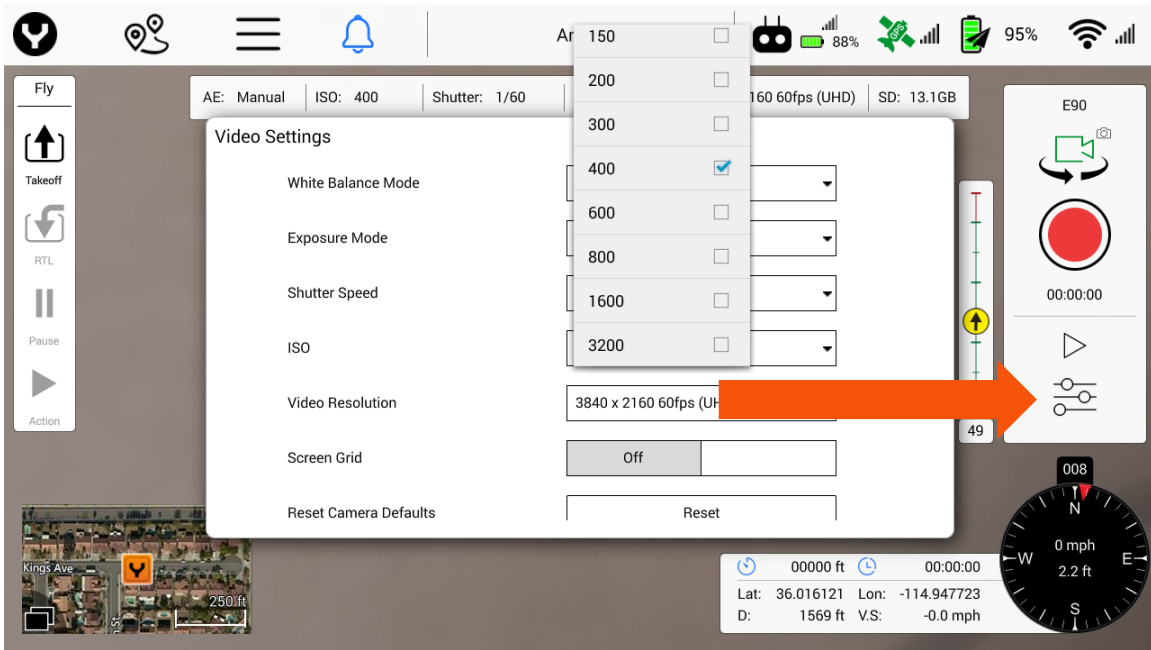

Video Recording Mode

Tapping the Camera Settings soft key in Video Recording Mode will enable the Pilot/Video Operator to access the Video Resolution setting.

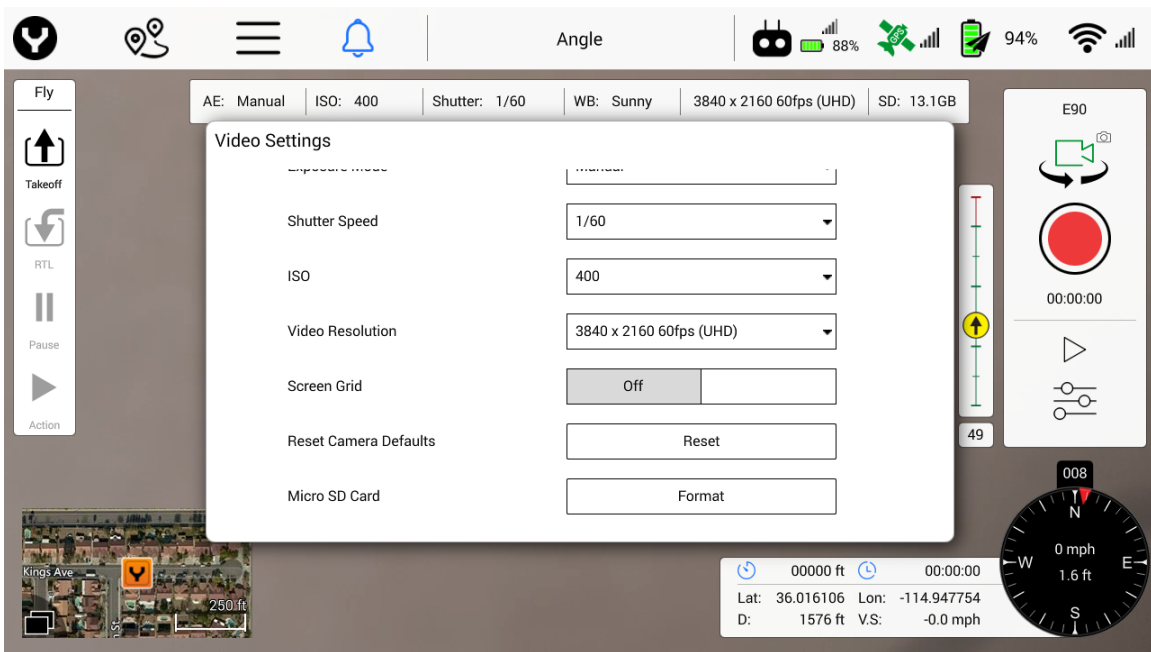

Video Format

The following settings are available in the Video Format drop down list for E90. This setting will only be available for 4K resolution @ 30 fps and below.

- H.264 (MPEG-4)
- HEVC (H265)

Video Resolution

The following settings are available in the Video Resolution drop down list for [E90](#)
Frames per Second (FPS)

- UHD - 4096 X 2160 at 60 FPS
- UHD - 4096 X 2160 at 50 FPS
- UHD - 4096 X 2160 at 48 FPS
- UHD - 4096 X 2160 at 30 FPS (HEVC option available)
- UHD - 4096 X 2160 at 25 FPS (HEVC option available)
- UHD - 4096 X 2160 at 24 FPS (HEVC option available)
- UHD - 3840 X 2160 at 60 FPS
- UHD - 3840 X 2160 at 50 FPS
- UHD - 3840 X 2160 at 48 FPS
- UHD - 3840 X 2160 at 30 FPS
- UHD - 3840 X 2160 at 25 FPS
- UHD - 3840 X 2160 at 24 FPS
- UHD - 2720 X 1530 at 60 FPS
- UHD - 2720 X 1530 at 48 FPS
- UHD - 2720 X 1530 at 30 FPS
- UHD - 2720 X 1530 at 24 FPS
- FHD - 1920 X 1080 at 120 FPS
- FHD - 1920 X 1080 at 60 FPS
- FHD - 1920 X 1080 at 48 FPS
- FHD - 1920 X 1080 at 30 FPS
- FHD - 1920 X 1080 at 24 FPS
- HD - 1280 X 780 at 120 FPS
- HD - 1280 X 780 at 60 FPS
- HD - 1280 X 780 at 48 FPS
- HD - 1280 X 780 at 30 FPS
- HD - 1280 X 780 at 24 FPS

*Recommended for general 4K recording/capture.

*Recommended for HD recording/capture

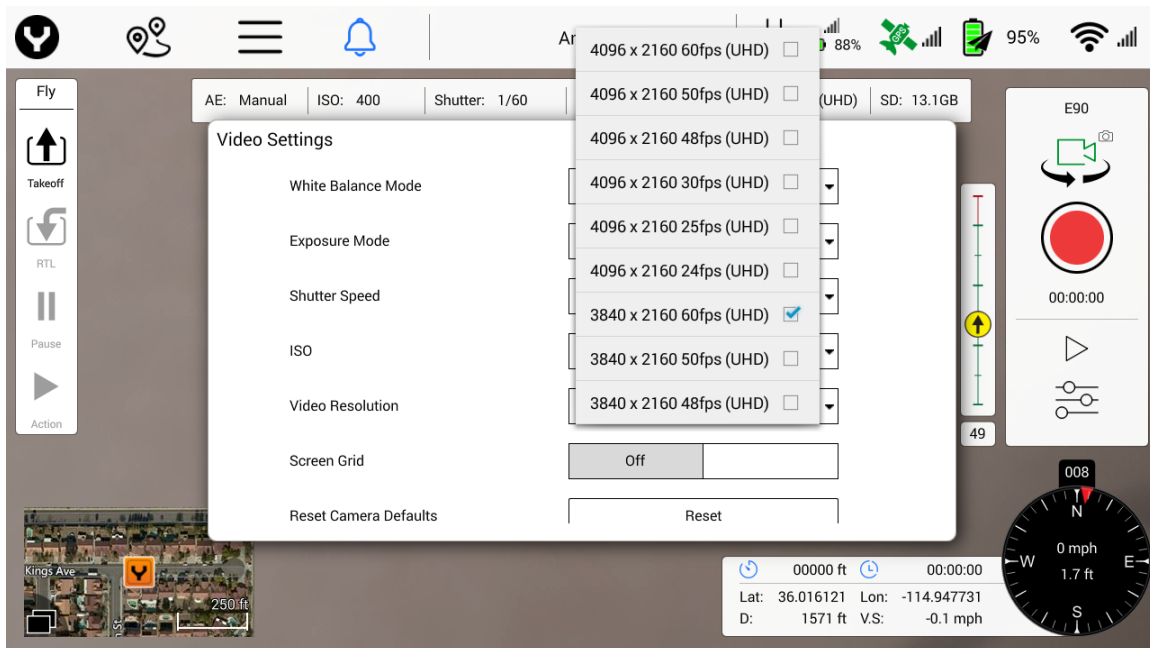

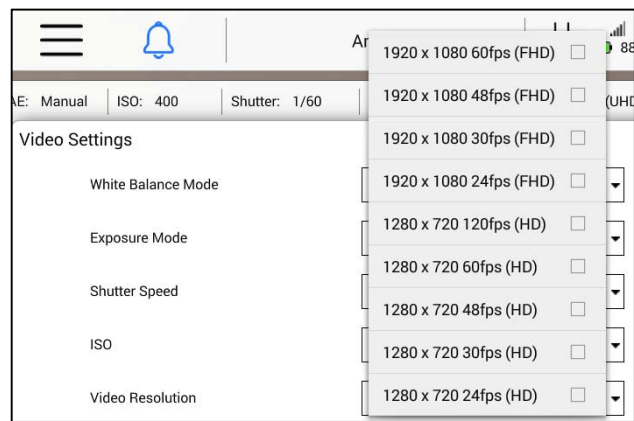
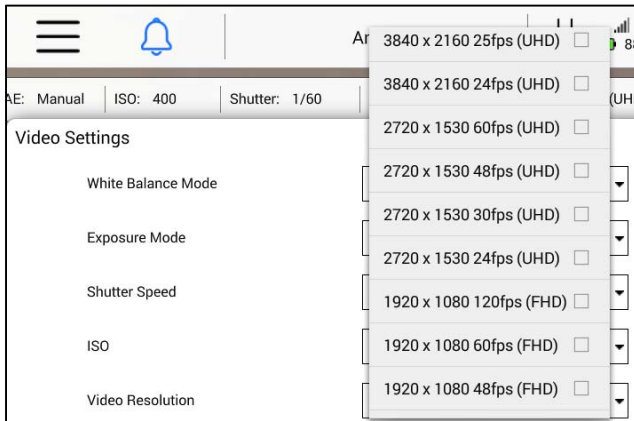

The following settings are available in the Video Resolution drop down list for [E50](#)

- UHD - 4096 X 2160 at 25 FPS
- UHD - 4096 X 2160 at 24 FPS
- UHD - 3840 X 2160 at 30 FPS
- UHD - 3840 X 2160 at 25 FPS
- UHD - 3840 X 2160 at 24 FPS
- UHD - 1920 X 1080 at 120 FPS
- UHD - 1920 X 1080 at 60 FPS
- UHD - 1920 X 1080 at 50 FPS
- UHD - 1920 X 1080 at 48 FPS
- UHD - 1920 X 1080 at 30 FPS
- UHD - 1920 X 1080 at 25 FPS
- UHD - 1920 X 1080 at 24 FPS

TIP! Use the 3840x2160 setting in most environments requiring 4K recording. 25/30p is the most common framerate; 50/60p is desirable if slow-motion is required for post flight preview or for smooth video production.

TIP! Use 1920 x 1080 25/30p when HD acquisition is required.

White Balance

The following settings are available in the White Balance drop down menu:

- **Auto** - Used when the conditions can vary and the operator doesn't want to manually adjust the settings
- **Incandescent** - Used when operating the camera in an indoor environment
- **Sunset** - Used during limited or fading light to bring out red and orange tones
- **Sunny** - Used in bright daylight, will adjust contrast to turn down brightness
- **Cloudy** - Used in cloudy conditions, will result in a brighter resolution
- **Fluorescent** - Used when operating in indoor environments with fluorescent lighting
- **Lock** - Locks out the ability to change the white balance

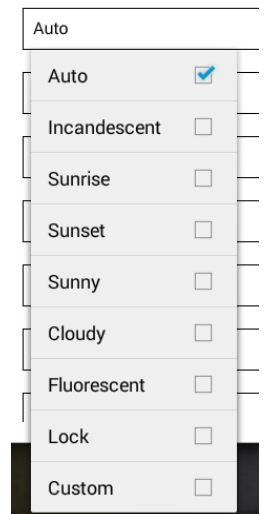

TIP! In environments where clouds and building shade may cause shifting exposure, allow the camera to auto-white balance for best results.

Exposure Compensation

The following settings are available in the Exposure Compensation drop down menu for [E90](#):

- -3.0
- -2.5
- -2.0
- -1.5
- -1.0
- -0.5
- 0
- +0.5
- +1
- +1.5
- +2
- +2.5
- +3

The following settings are available in the Exposure Compensation drop down menu for [E50](#):

- -2.0
- -1.5
- -1.0
- -0.5
- 0
- +0.5
- +1
- +1.5
- +2

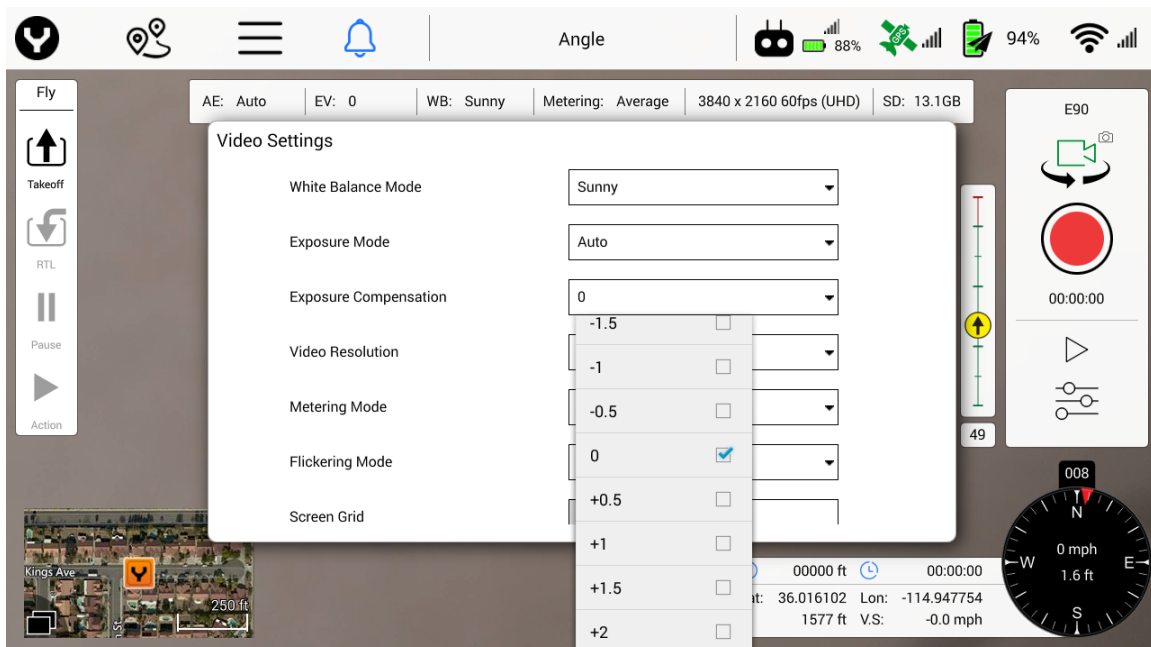

TIP! When flying without filters, it is good practice to under expose by .5, providing dynamic range for post-processing of images or video.

Photo Aspect Ratio

The aspect ratio of photos may be set in this dropdown box. Users may choose between three settings;

- 3:2 (common for print sizes of 4 x 6 to 20 x 30, and similar to 35mm fullframe SLR cameras)
- 4:3 (common for MFT cameras, compact cameras. 4:3 photos generally require cropping for most print frames)
- 16:9 (common aspect ratio for matching video, not a common photo aspect ratio outside the world of video).

The 3:2 format is the most common format for most photography uses.

ISO

The following settings are available in the ISO drop down menu for [E90](#) (to access the ISO menu Auto Exposure needs to be disabled):

- 100
- 150
- 200
- 300
- 400
- 600
- 800
- 1600
- 3200 (max for video mode)
- 6400 (max for photo mode)

The following settings are available in the ISO drop down menu for [E50](#) (to access the ISO menu Auto Exposure needs to be disabled):

- 100
- 150
- 200
- 300
- 400
- 600
- 800
- 1600 (max for video mode)
- 3200 (max for photo mode)

Shutter Speed

The following settings are available in the Shutter Speed drop down menu.

TIP! To access the Shutter Speed menu, Auto Exposure must be disabled. All values are in seconds.

- 4
- 3
- 2
- 1
- 1/25
- 1/30
- 1/50
- 1/60
- 1/100
- 1/125
- 1/250
- 1/500
- 1/1000
- 1/2000
- 1/4000
- 1/8000

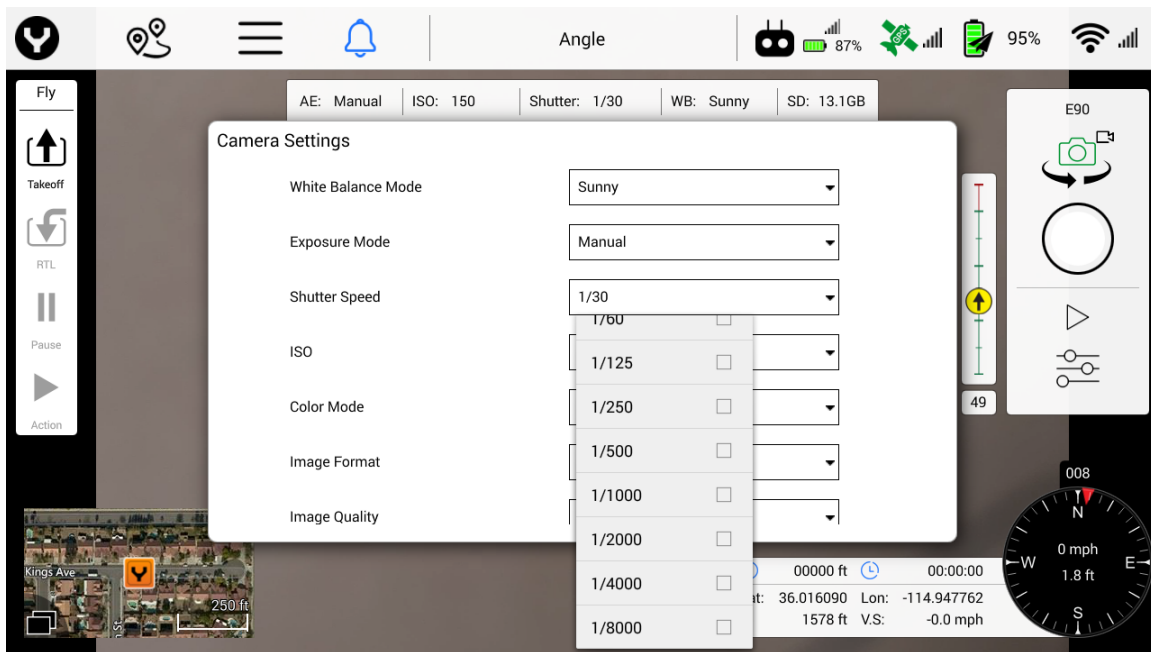

TIP! Shutter speeds may be manually slowed, or slowed in auto-mode through the use of Neutral Density filters. The [E90](#) and [E50](#) cameras offer a filter adapter ring in the box, allowing Pilots to purchase filters of choice. Shutter speeds slower than 1/250 are desired when avoiding rolling shutter artifacts. Slow shutter speeds generally allow for greater color, yet can induce motion blur if the aircraft is moving very fast or being buffeted by high winds aloft.

Color Mode

The following settings are available in the Color Mode drop down menu (to access the Color Mode menu the ST16S must be in Still Image Mode):

- Neutral
- Enhanced
- Night
- Vivid
- Unprocessed

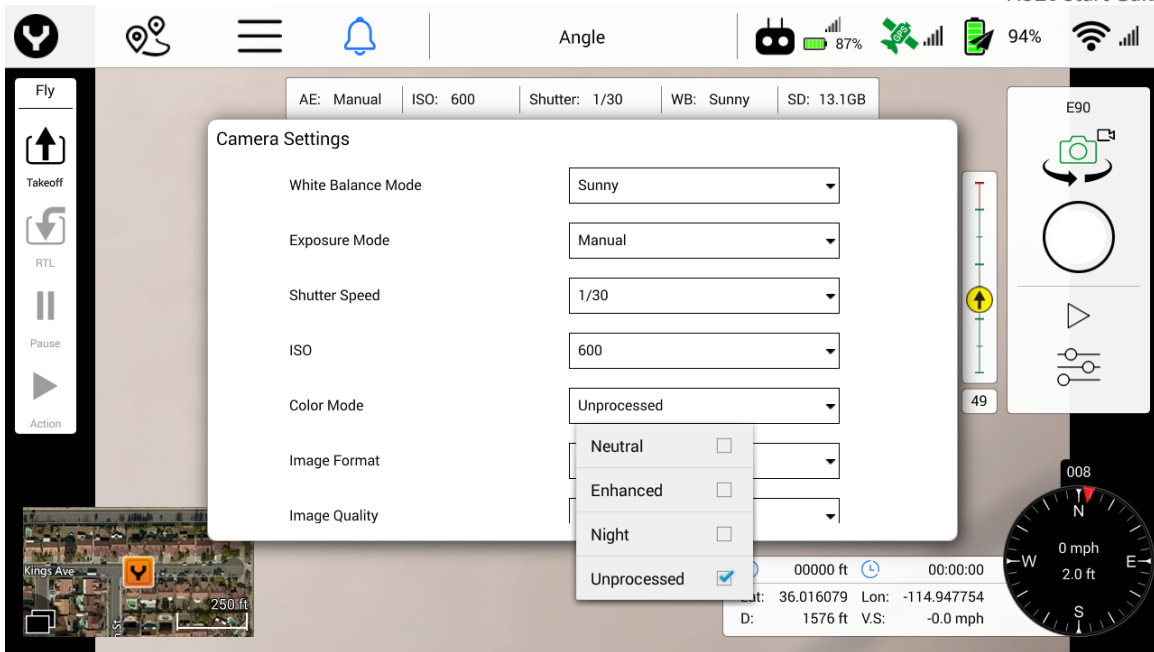

For images that will be processed in photo, mapping, or video processing software after a flight, Yuneec recommends using either “Unprocessed” or “Neutral” color modes for best results/greatest dynamic range. Using “Vivid” or “Enhanced” for mapping projects may be oversaturated.

Image Format

The following settings are available in the Image Format drop down menu for E90:

- Jpeg
- Jpeg+DNG

JPG is used for most applications, reporting, online or email display/transfer. Some stitching and orthomosaic software will only accept jpg images. However, most post-processing tools are faster with digital negative/ .dng files.

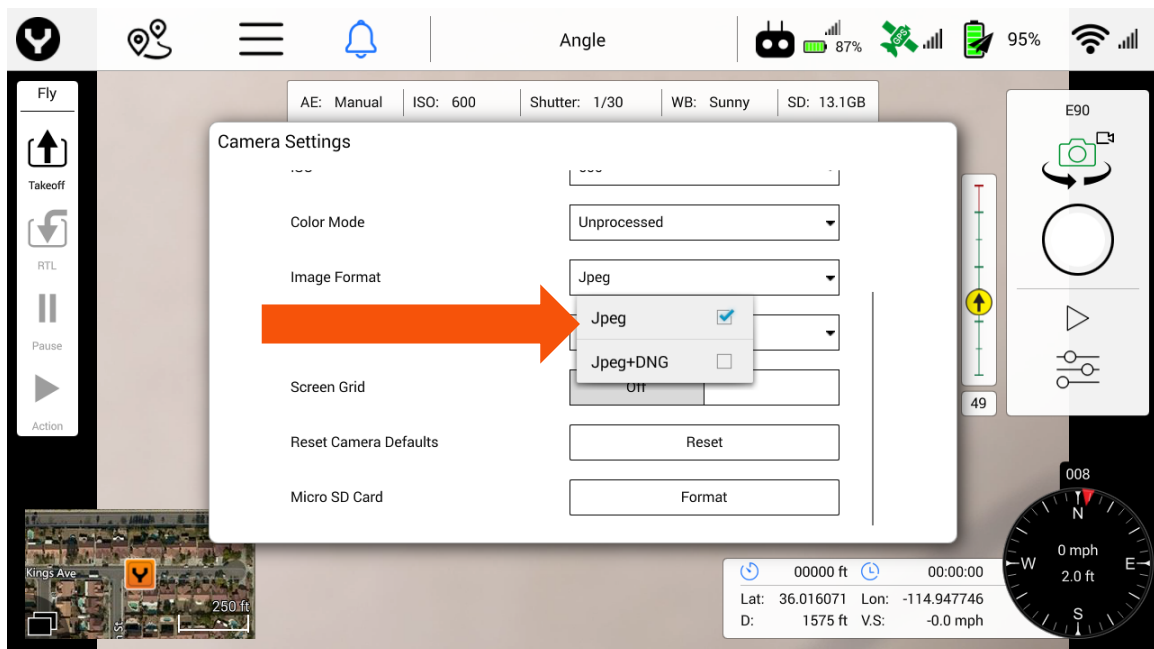

The following settings are available in the Image Format drop down menu for E50:

The following settings are available in the CGOET camera

- Jpeg
- Jpeg+DNG

1920 x 1080 30p (North America)
160 x 120 9p (North America)

1920 x 1080 25p (EU)
160 x 120 9p (EU)

Image Quality

The following options are available for the image quality drop down menu for E90:

- Low
- Medium
- High
- Ultra

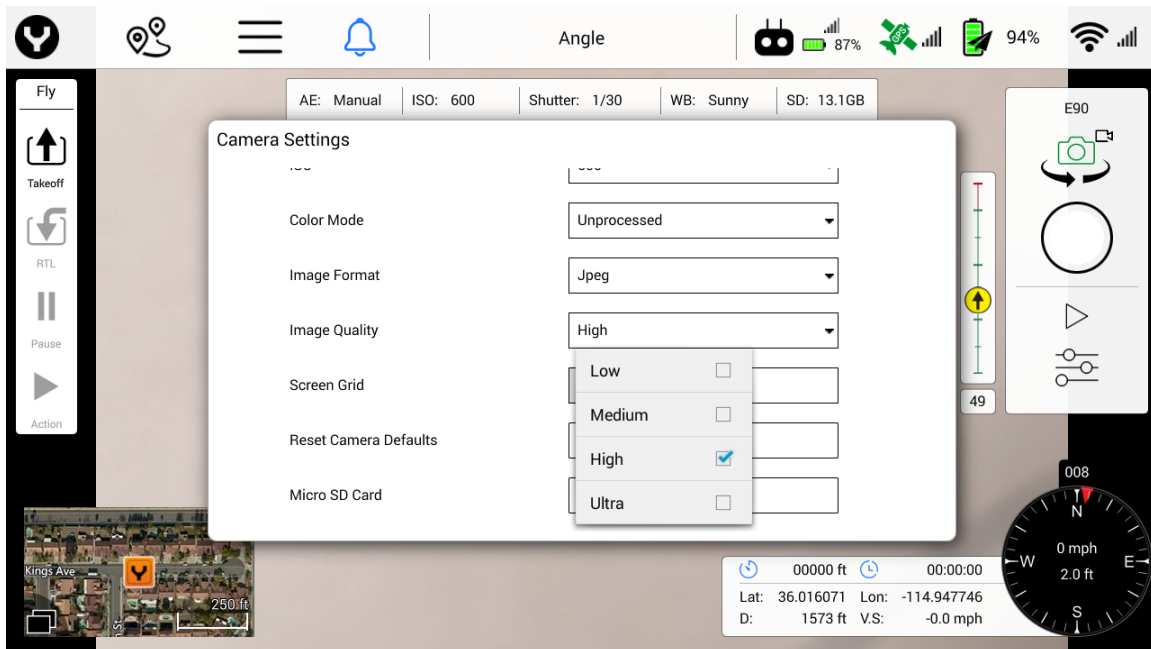

The E50 does not offer the Image Quality option.

Distortion Correction

The E90 is a 23mm equivalent lens, meaning it's a wide-angle lens. As a result there is optical distortion that may be seen in wide horizon images. The image may be flattened/corrected in-camera using the Distortion Correction feature. This will flatten the horizon.

Depending on lighting conditions and Color Mode choices, using this feature may cause "fringing" (also known as "dispersion") on the edges of the photo, showing as purple noise. This is a result of in-camera processing. To avoid chromatic "fringing," correct photos in a photo editing application for superior results. Shooting in DNG will go a long way in correcting dispersion issues.

Metering Mode

The following settings are available in the Metering Mode drop down menu:

- **Average** - Takes readings of the entire frame to adjust the image
 - **Averaging mode** looks at the entire content of the frame and adjusts to a median point for best overall exposure. Average mode is ideal for large landscapes where the ground is not part of the image, while objects in the foreground might be, such as a tall building against the sky. Some systems refer to this metering mode as “Matrix” metering.
- **Center** - Takes a reading from the center of the frame to adjust the image
 - **Center-weighted modes** use the center portion of the frame to set the exposure value. Center mode ignores the corners of the frame to focus on a larger area in the center of the frame. An ideal use of Centering mode might be when inspecting a communications tower against a bright blue sky, exposure should be set based on the tower, not the sky. This may cause the sky to be over exposed, particularly in backlit scenarios, but will allow for the tower to be properly photographed.
- **Spot** - Takes a reading from a specific spot in the frame to adjust the image
 - **Spot mode** is useful when identifying a small area in an object, or shooting against a bright background such as snow or sky. The camera will identify a small spot in the center/point of focus, and adjust the exposure accordingly. Another example might be when photographing the moon, the moon is very small and very bright. The only point of exposure value would be the moon itself, therefore, spot-metering would be the correct choice for this scenario.

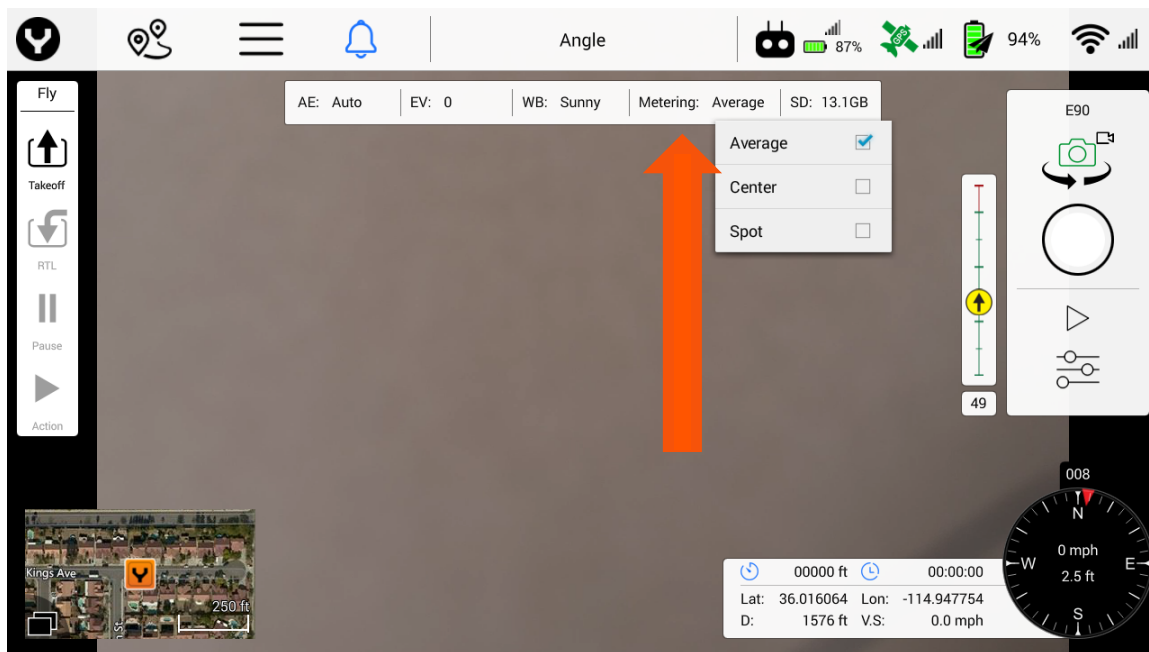

Note: To access the Metering Mode drop down menu, Auto Exposure must be enabled to view Metering Modes.

IMAGE COUNT

Whether manually capturing images, or capturing images in a mapping mission, DataPilot™ will display a count of captured images in the Photo indicator box, just below the Photo trigger soft key. This provides instant feedback indicating photos are being captured/stored on the MicroSD card inserted to the camera.

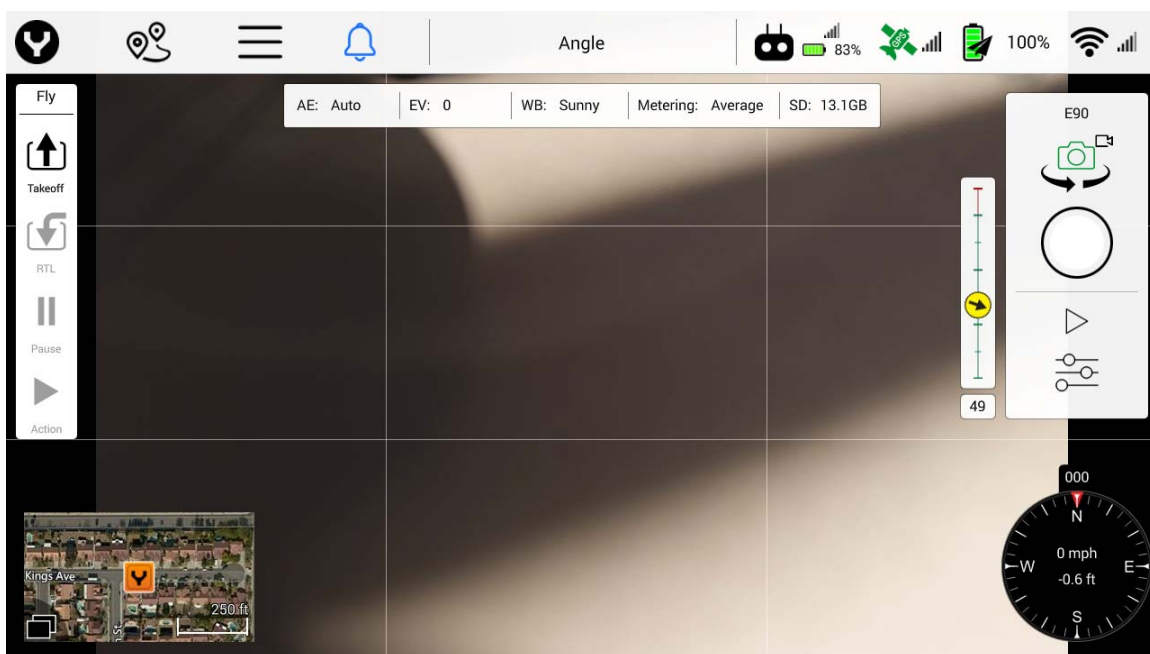
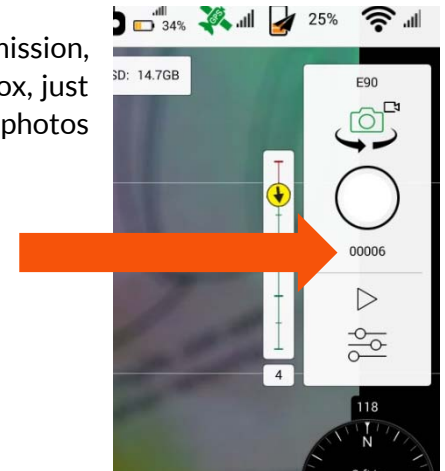

Tapping the **Screen Grid** soft key will display a rule-of-thirds grid in the Camera View. The line matrix/rule of thirds is useful to ensure that all images are taken with the same focus point of view. Some kinds of photographs will always center the subject in the middle square, while artistic images frequently put the subject on a “power point,” or points at which the lines intersect.

Reset Camera Defaults

Using the Reset Camera Defaults soft key will reset the camera settings to factory defaults.

Micro SD Card Format

Using the Micro SD Card Format soft key will format any microSD Card installed in the microSD Card slot on the camera.

WARNING

The formatting function will delete all data on the microSD Card and cannot be undone.

Camera Info Bar

The camera info bar displays the current camera settings including AE (auto exposure mode), EV (exposure value), WB (white balance mode), metering mode, photo/video resolution, and the remaining free space on the connected camera's microSD card. If no SD card is inserted, the free space will show 'None'.



The camera bar is a display-only function. Camera settings are edited in the Camera Settings dialog.

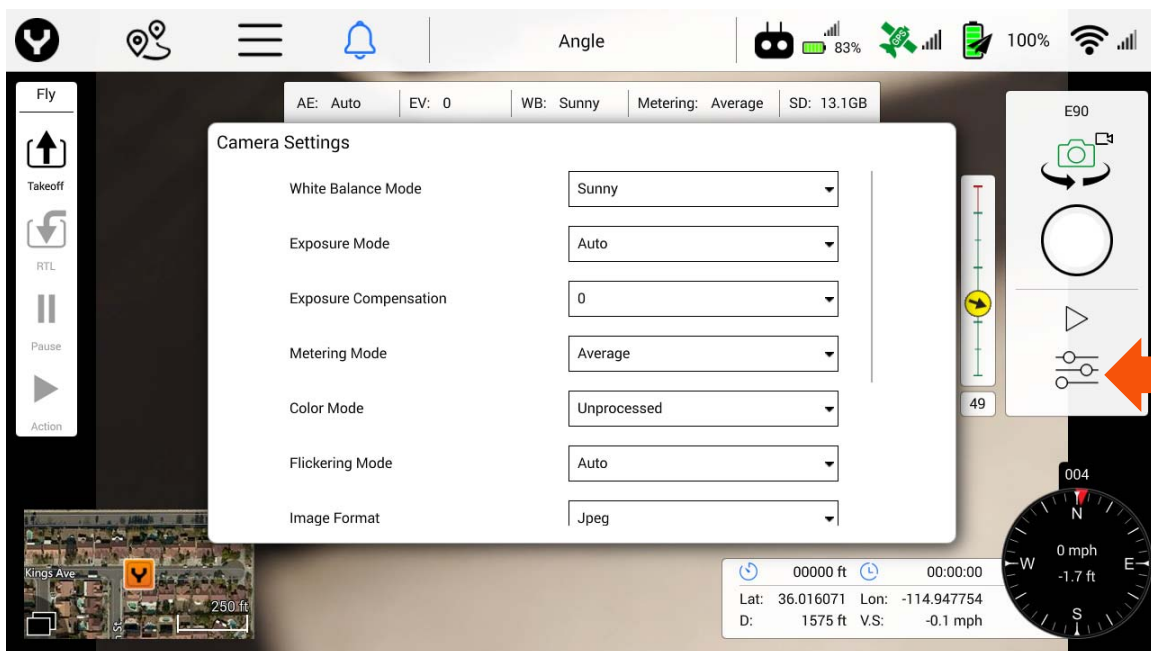

Gimbal Indicator

The gimbal indicator is located to the left of the Camera Control panel. The pitch indicator (vertical line) displays the current pitch of the camera.

The green section represents the normal pitch range, i.e. 0 degrees (level on the horizon) to 90 degrees (straight down).

The red section represents pitch angles above the horizon.

To point the gimbal 20 degrees upwards, flip switch S1 to the down position.

The absolute pitch value is shown right below the indicator. The yaw indicator displays the current yaw of the camera relative to the H520.

The yellow arrow shows the yaw angle of the gimbal, for which pointing upward is in the direction of the nose of the H520, and downward in the direction of the back of the aircraft.

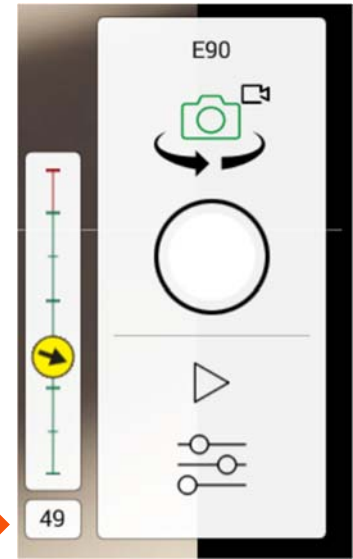

USING THE CGOET FOR H520 THERMAL/RGB CAMERA

The CGOET for H520 is a 3-axis self-stabilizing gimbal camera compatible with H520. It combines an infrared camera and an RGB camera into a single unit able to capture thermal spectrum and visible light images or video at the same time. The CGOET for H520 was developed for end-users who require thermal imaging for a wide array of creative, commercial and public service applications.

CGOET MICROSD CARD INSTALLATION

NOTICE: Before using the CGOET, a SD card should be inserted into the camera.

Step 1) Slide a blank memory card into the card slot.

Step 2) When fully inserted, the card will click into place. To remove the card, push against the edge of the memory card and lightly press it further into the camera. The card springs out far enough to be removed.

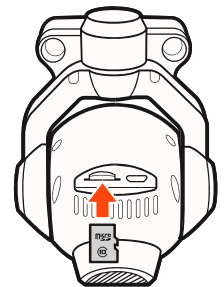

ATTACHING CGOET GIMBAL CAMERA TO H520

Step 1) Place the nose of H520 towards the user.

Step 2) According to the direction indicated by the arrow on the top of the gimbal, slide the damping plate of the gimbal to the camera base of the H520.

NOTICE: The CGOET gimbal camera should be installed in the same direction as the arrow printed on the top of the gimbal.

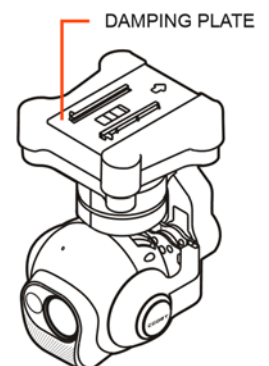

The gimbal will lock in place.



CONNECT/BIND THE CAMERA

Step 1) First, switch on ST16S Ground Station and then power on the H520.

Note: For safety, always power the ST16S (or any other control device) prior to powering on the aircraft/vehicle.

BINDING H520 AND CGOET TO ST16S

Step 1) Press the Wifi icon in the upper right screen, and a connection dialog will appear.

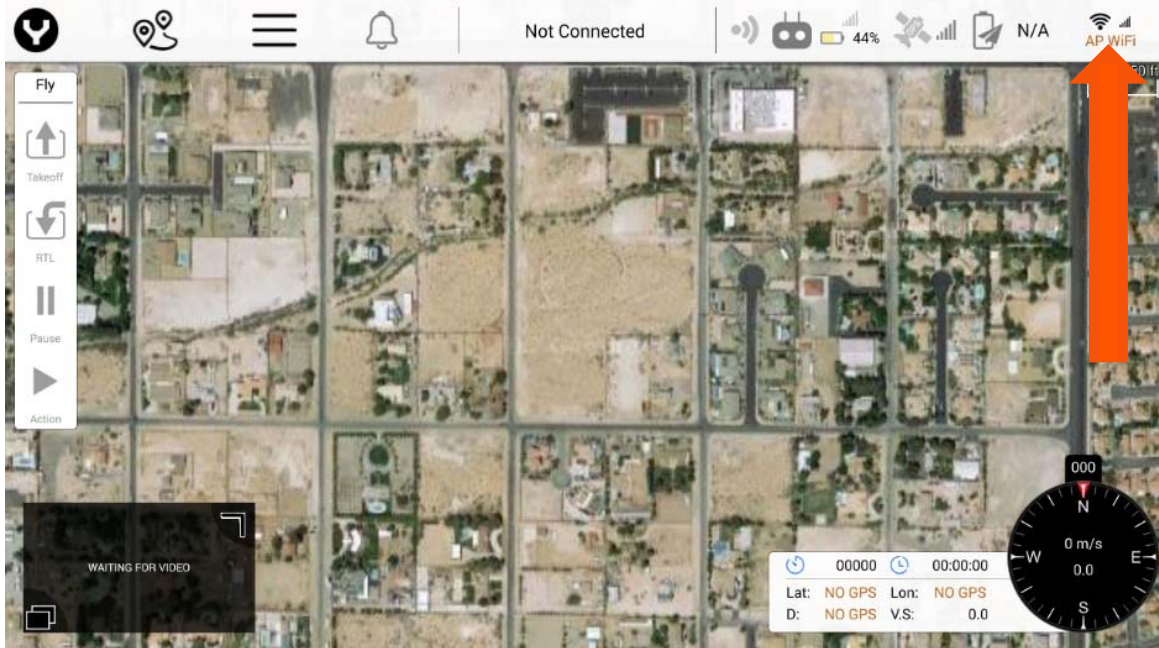

Step 2) Tap the “Camera Select” button with “CGOET” in the field. A password field will open.

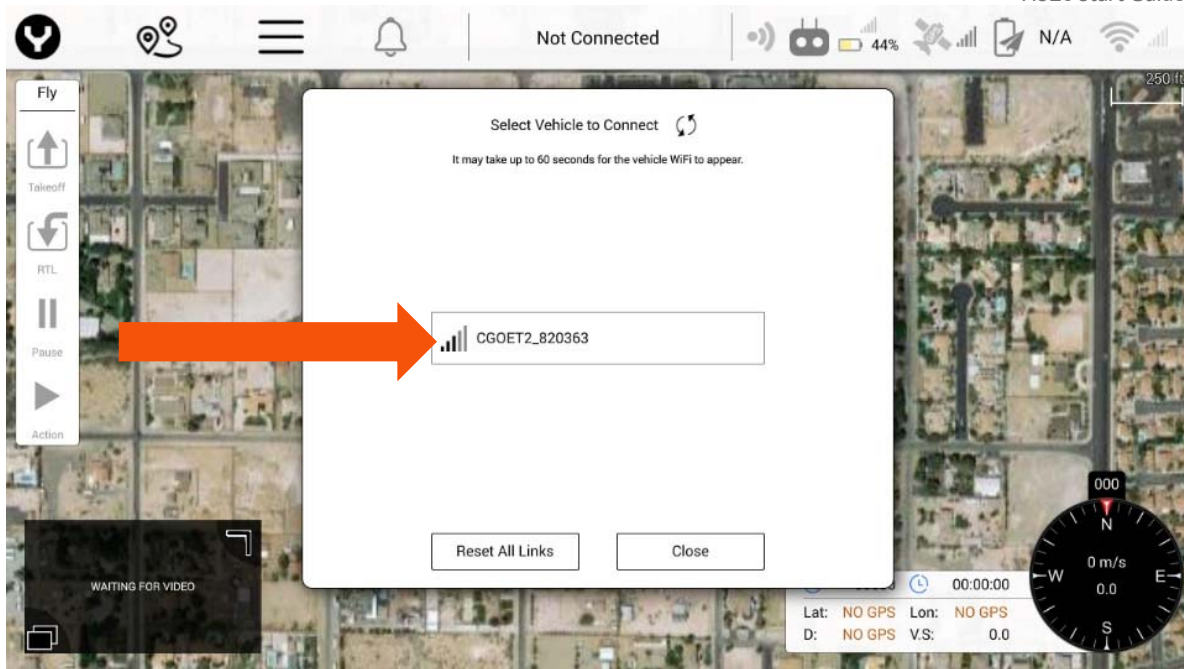

Step 6) Input the password "1234567890" as requested, and tap "OK".

Step 7) The ST16S will begin to bind, indicated by a thin green progress bar at the top of the DataPilot™ interface. When the green line reaches the right side of the interface, the H520 will chime and video will appear on the screen.

CAMERA CONTROLS

GIMBAL CAMERA TILT CONTROL

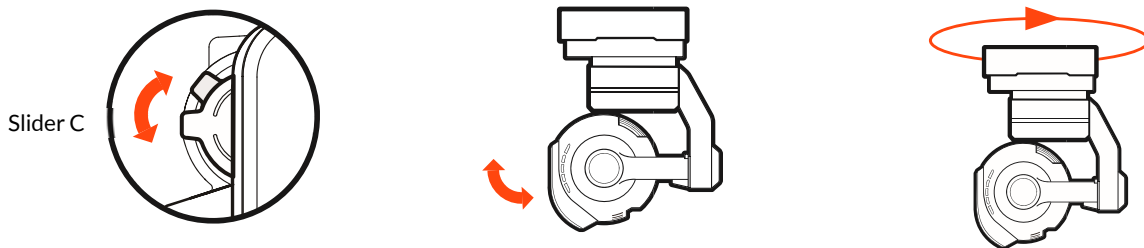

GIMBAL CAMERA PAN CONTROL

Using the "Slider C" Tilt Control found on the left underside of the ST16S, the camera pitch may be adjusted between 90 and +20 degrees for Nadir (straight down) angles, or for an upward tilt of 20 degrees.

There is a gimbal pan mode switch on ST16S---S2. When the switch position is up, the gimbal camera is in Follow Mode. The pan control of the gimbal camera is now disabled. The gimbal camera will adjust its pan

direction according to the aircraft's movements. When the switch is in the middle position, the gimbal camera is in Follow Pan Controllable Mode, the gimbal camera will adjust its pan direction according to the aircraft's movements. Meanwhile, the pan control is activated, use the K1 to set the pan position of the gimbal camera. When the switch position is down, the gimbal camera is in Global Mode. The pan direction of the gimbal camera will be fixed regardless of the aircraft's movements. Use the K1 to set the pan position of the gimbal camera.

STILL CAPTURE AND VIDEO RECORDING

TO CAPTURE A STILL PHOTO

Press the button located near the lower left corner of the ST16S. An audible 'shutter' sound from the ST16S and the green LED indicator on the front of the CGOET will blink blue once every time when taking a photo. It will take approximately 1-2 seconds to capture the photo and before another still photo may be captured.

Tap the Camera settings icon at the bottom of the Camera Menu. The automatic shooting interval may be set in the main camera menu. The shooting interval may be set from 5-60 seconds (For example, if the shooting interval is set at 20 seconds, the camera will take a photo every 20 seconds). Additionally, the interval/delay will be displayed in the photo capture button in the camera control.

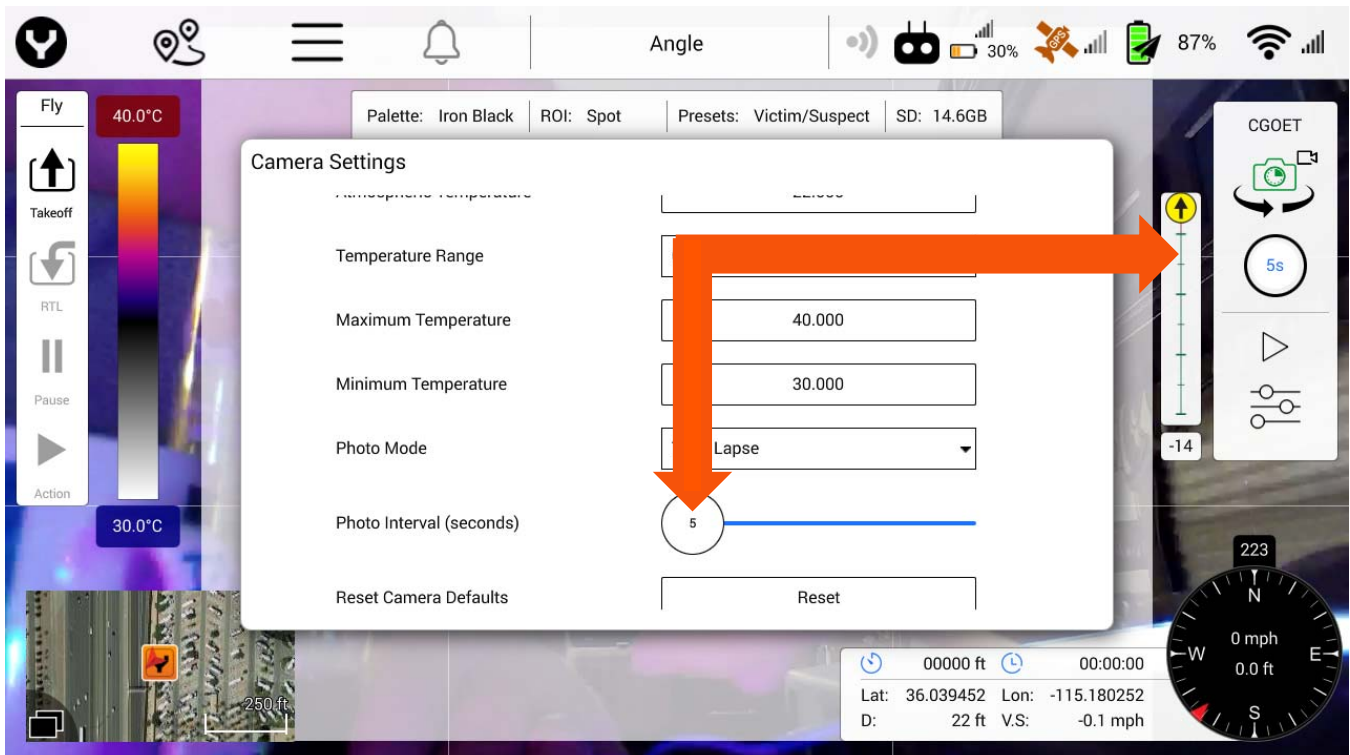

RECORDING VIDEO

Press the button located near the lower right corner of the ST16S. An audible indication from the ST16S will be heard each time the recording starts/stops. While video is recording, the LED indicator on the front of the CGOET will flash blue and green.

Regardless of what is displayed on the ST16S display, both IR and RGB/visible light data is recorded. Each file may be viewed separately in most video editing applications.

Video from the CGOET for H520 is 1920 x 1080 at 30 frames per second (fps).

CAUTION: Video recording must stop before capturing still photos. It will take approximately 1-2 seconds to capture a still photo and before capturing another image while in video mode. Images taken in video mode are 1920x1080 resolution.

Note: ALWAYS STOP recording video before turning off H520 to avoid data loss. If the H520/CGOET is accidentally shut off before recording has stopped, re-insert micro SD card (if removed) and turn the system on again. Wait approximately 20 seconds until the camera LED starts to glow solid green indicating the last video file was recovered.

NOTICE: The captured pictures and videos are stored on the camera MicroSD card inserted in the camera.

CAMERA PARAMETER SETTING

The users can adjust the parameter settings when monitoring the ST16S Ground Station screen. On the right side of the screen in the Camera menu, users may choose one of four display modes for the images shown on the screen.

1) **“Picture In Picture”** : Press the “Picture In Picture” option, the RGB images and infrared images will be displayed separately on the screen with the IR image displayed in the upper left corner.. The center-point temperature detected by the infrared camera will be shown at the center of the infrared images.

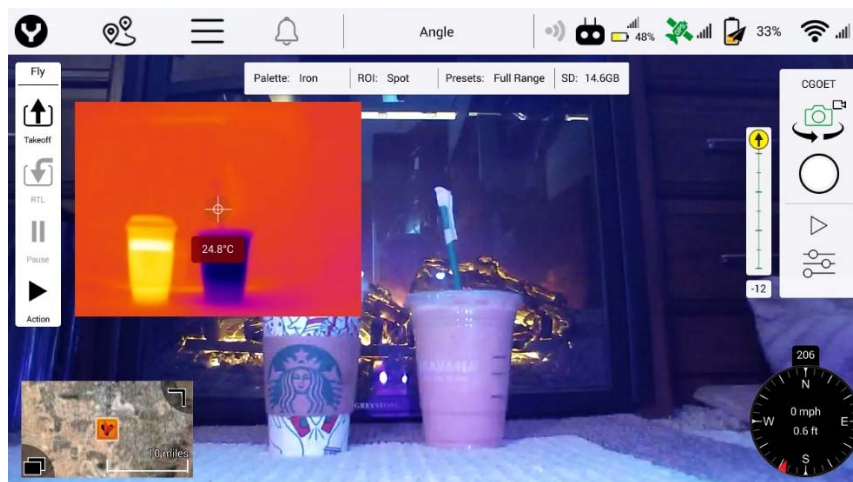

- 2) **“Blend”** : Choose the “Blend” option, the visible images and infrared images will be overlapped on the screen. The center-point temperature detected by the infrared camera will be shown at the center of the infrared images.
- 3) **“Full”** : Press the "Infrared" option and the screen will only display the infrared images. The center-point temperature detected by the infrared camera will be shown at the center of the infrared images.
- 4) **“OFF”** : Tap the “OFF” option and the screen will only display the RGB images.

OTHER SETTINGS

The CGOET for H520 may be operated using only presets, or manually controlled to specific user settings. If at any time a user-selected value becomes confusing or undesired, selecting a preset will clear all user-settings.

ROI: Region of Interest. Temperature measurement is taken from either a SPOT (single pixel point) or from a Center Area on the screen, averaging the temperature in that specific region. In the illustration below, the Region Of Interest shows a general temperature around the cup.

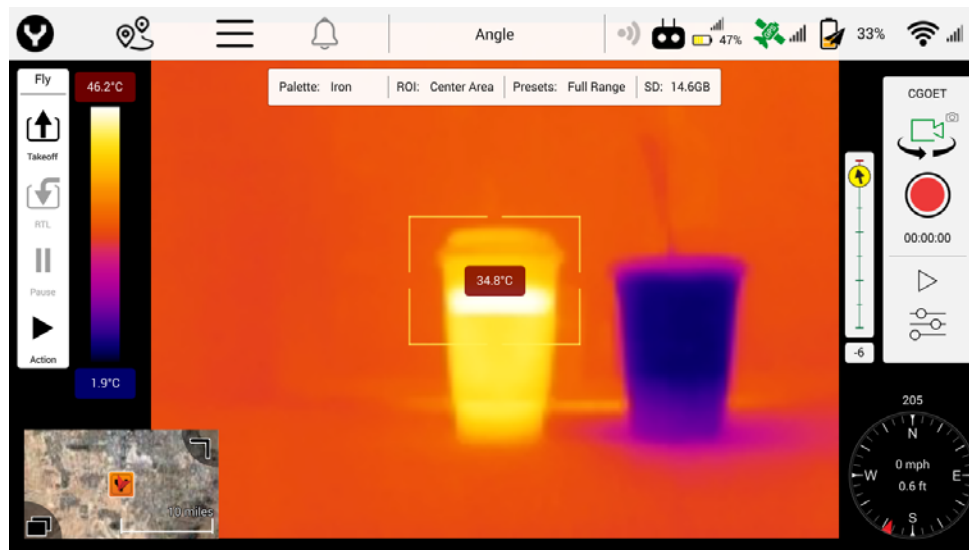

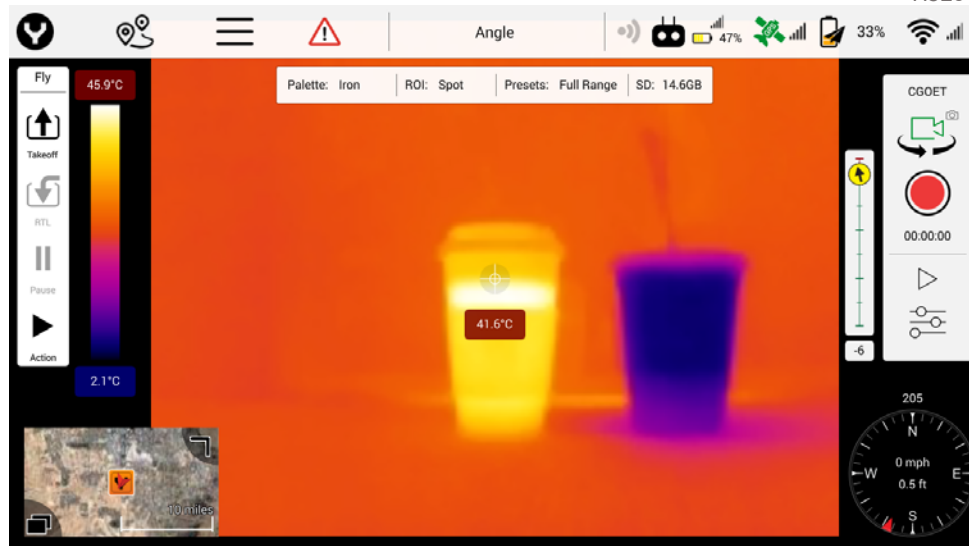

In the second image, the Region Of Interest is set to “Spot,” identifying a specific temperature point. In these two examples, there is a difference of 9.8° Celsius/12° Fahrenheit.

OPACITY: This is a slider dedicated to allowing users to reduce opacity of the IR images (available only in FULL mode), enabling details of the measured object to show through. This allows users to treat the IR camera as though it is a Detection and Identification-grade thermal camera. In low light scenarios, users a setting of less than 70% is typically optimal. In lit scenarios, a value of 75-85% is frequently preferred.

PRESETS: The CGOET for H520 has several presets related to common uses of Thermal camera systems. While these settings are optimized for specific users, they are also valuable starting points for experienced users to begin with when modifying parameters for specific uses.

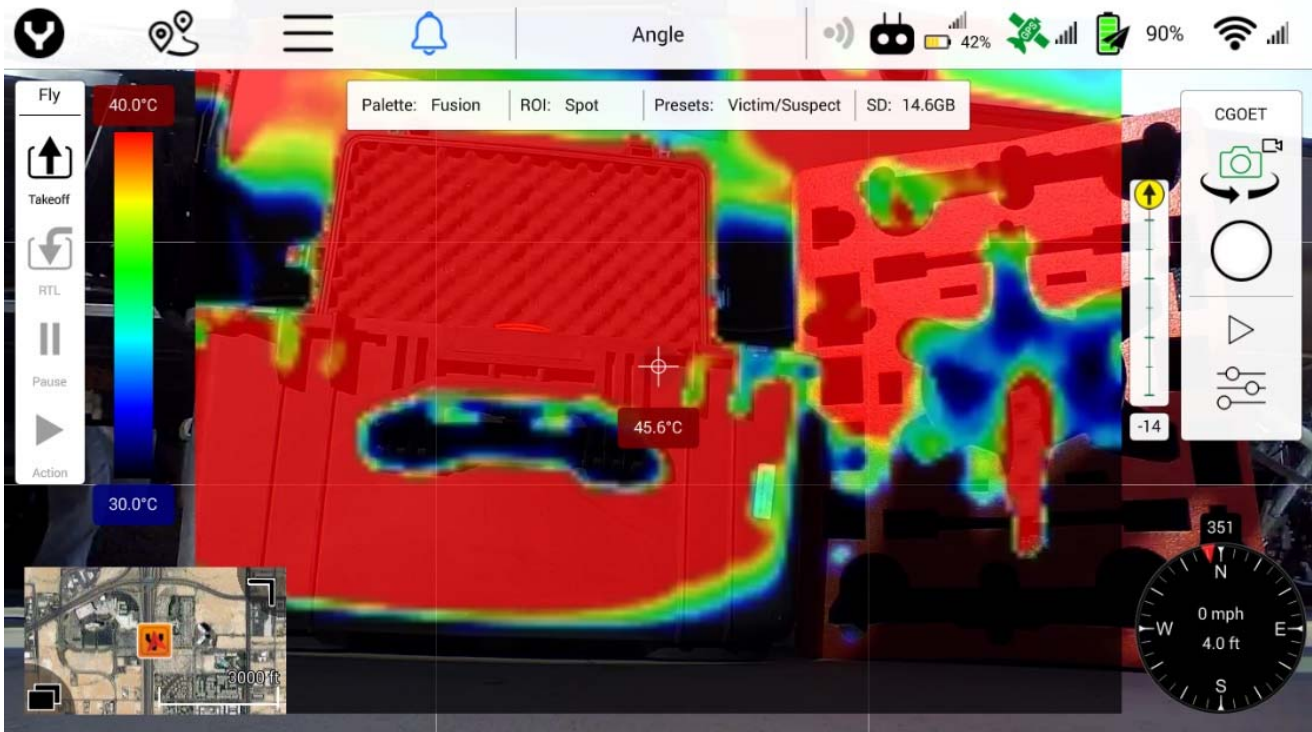

In this image, opacity is set to 85%. Details are visible through the IR image.

INFRARED PALETTE: The CGOET for H520 has several palettes. These are methods in which various temperature ranges may be displayed. There is no right nor wrong palette for any particular use; these are personal preferences. We recommend users experiment with various palettes. Palettes may also be accessed in the Status bar at the top of the DataPilot™ interface.

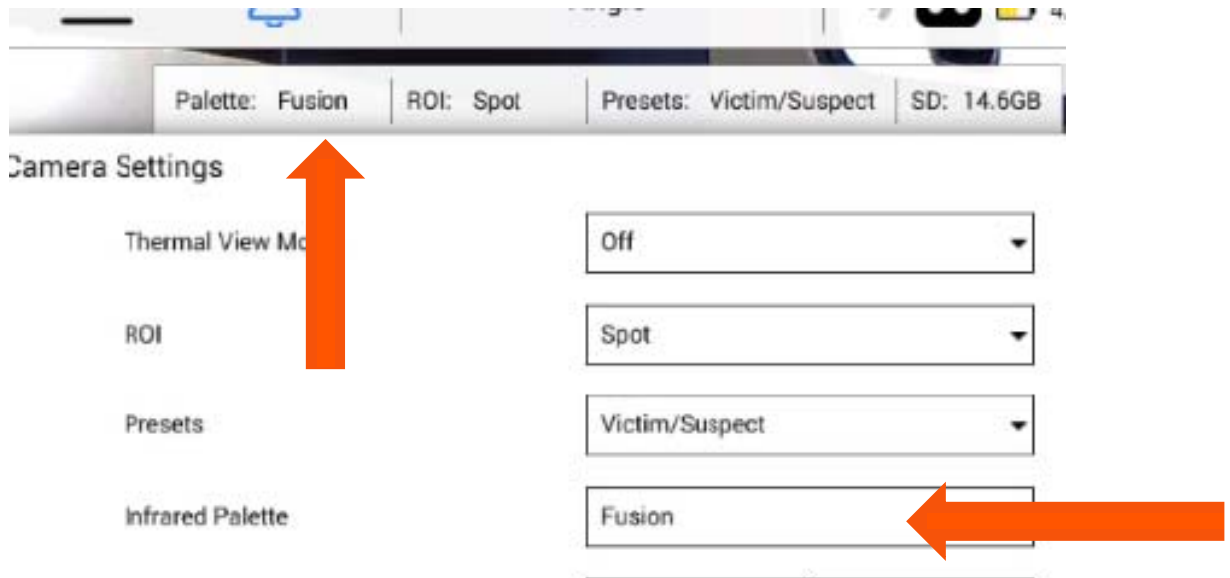

Enable IR Locked Range: Manually set the highest and lowest temperature. The default mode is automatic acquisition, when it is switched to the manual mode, the "lock button" on the right side of the screen will be shown in locked form.

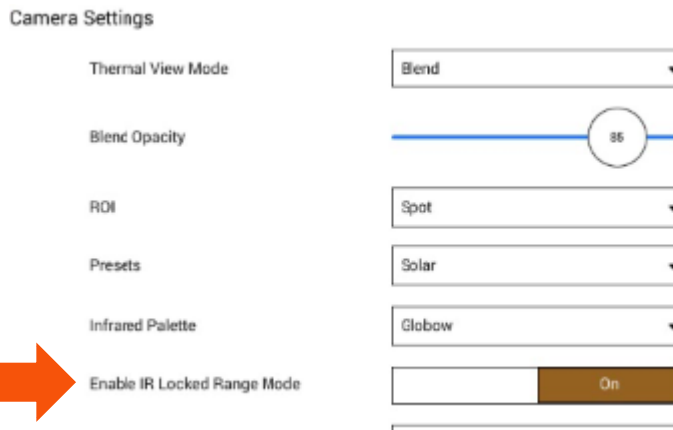

Auto Calibrate: Automatically calibrate the temperature to the current environment.

Atmospheric Parameters: Manually set the atmospheric parameters (Emissivity and Atmospheric Transmission). The default mode is automatic acquisition. It is recommended that this mode be left enabled, unless there is a specific reason that the camera should not ignore atmospheric conditions.

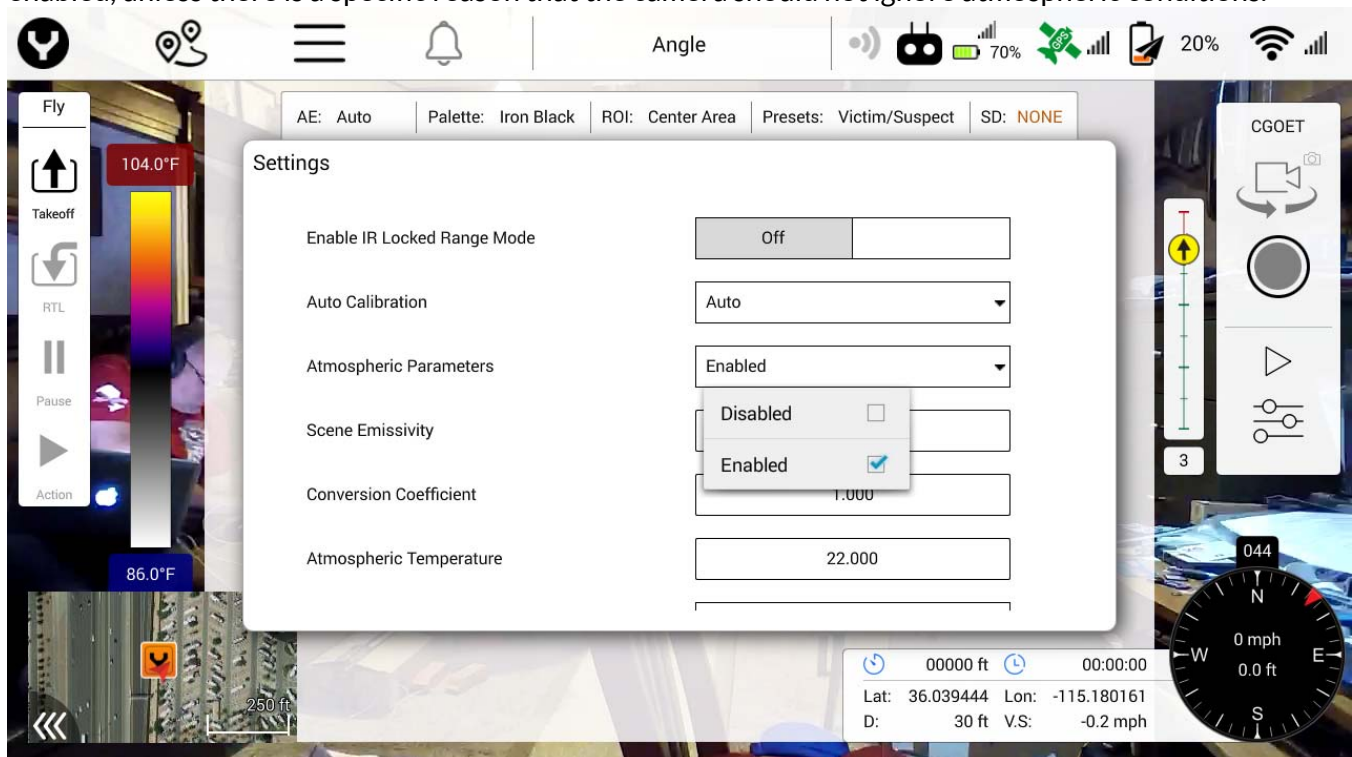

Temperature Range: This toggles on/off adjustments that have been made to minimum/maximum temperature values.

Min/Max adjustment fields: Manually set the highest and lowest temperature. The default mode is automatic acquisition, when it is switched to the manual mode, the "lock button" on the right side of the

screen will be shown in locked form. These fields allow very narrow temperature ranges for situations where a specific temperature range is a search parameter.

Reset Camera Defaults: Selecting this option resets the camera to all factory settings.

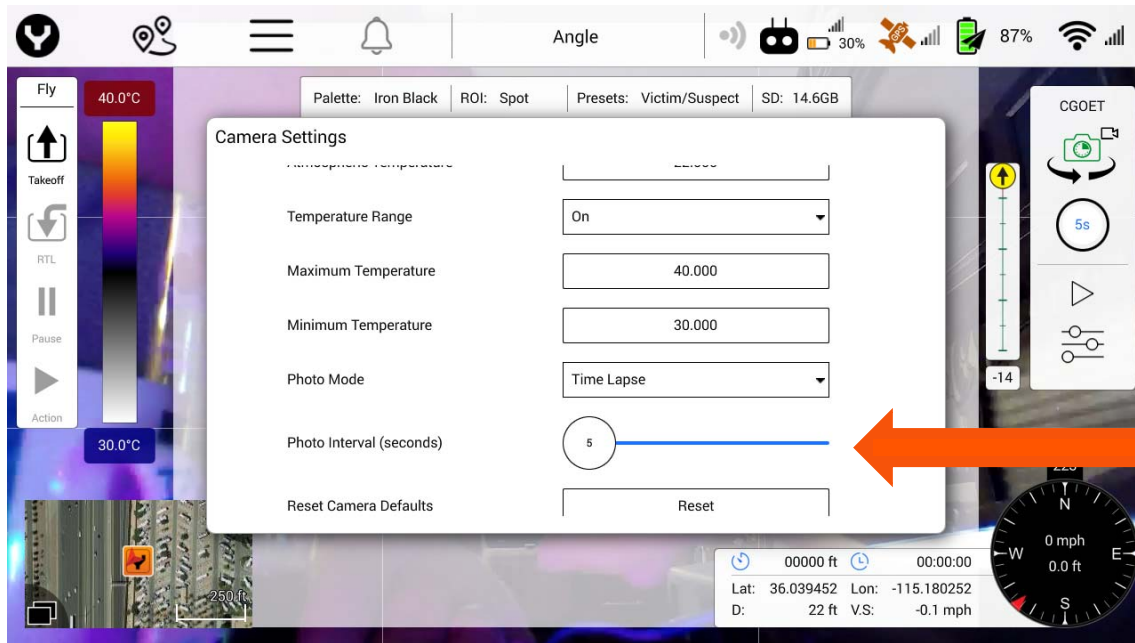

Format MicroSD card: Using this option will format the MicroSD card in the CGOET. This will not format any MicroSD card in the ST16S card slot. Formatting the card using this feature ensures correct formatting for operations with the CGOET.

GENERAL SETTINGS MENU

Tap the horizontal three-line icon on the top menu bar of the ST16S. The General Settings Menu enables the Pilot to modify H520 and ST16S settings prior to launching the H520. These settings will auto-update the first time DataPilot™ is launched and the “Units” preference is set. Users may change original preferences at any time via the General Settings Menu.

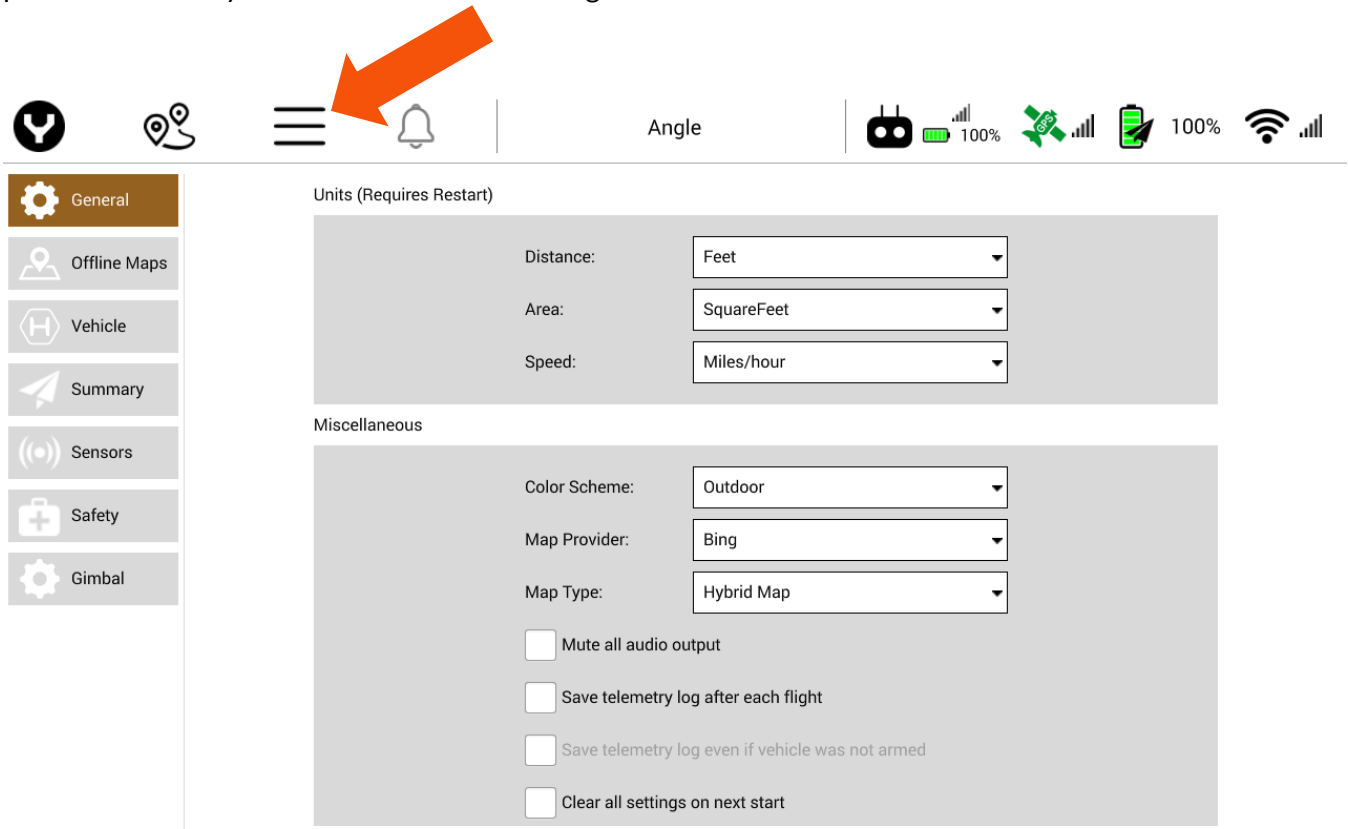

GENERAL

Settings in the General menu include Units and Miscellaneous settings as well as ability to control LED settings on the H520 aircraft.

UNITS

Changes to the Units requires DataPilot™ to restart prior to taking effect.

Note: DataPilot™ must be closed down and re-started after changing Units values.

DISTANCE

The Distance menu allows the pilot to select the displayed distance units, either Feet or Meters.

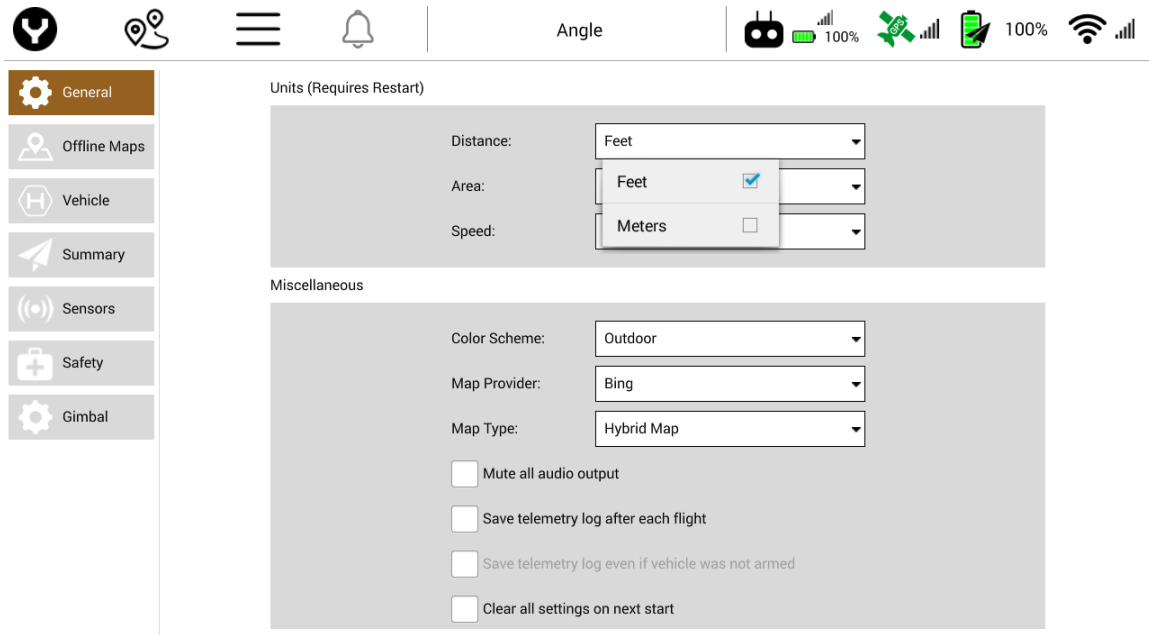

AREA

The Area drop down menu allows the Pilot to change display indication between the following settings:

- Square Feet
- Square Meters
- Square Kilometers
- Hectares
- Acres
- Square Miles

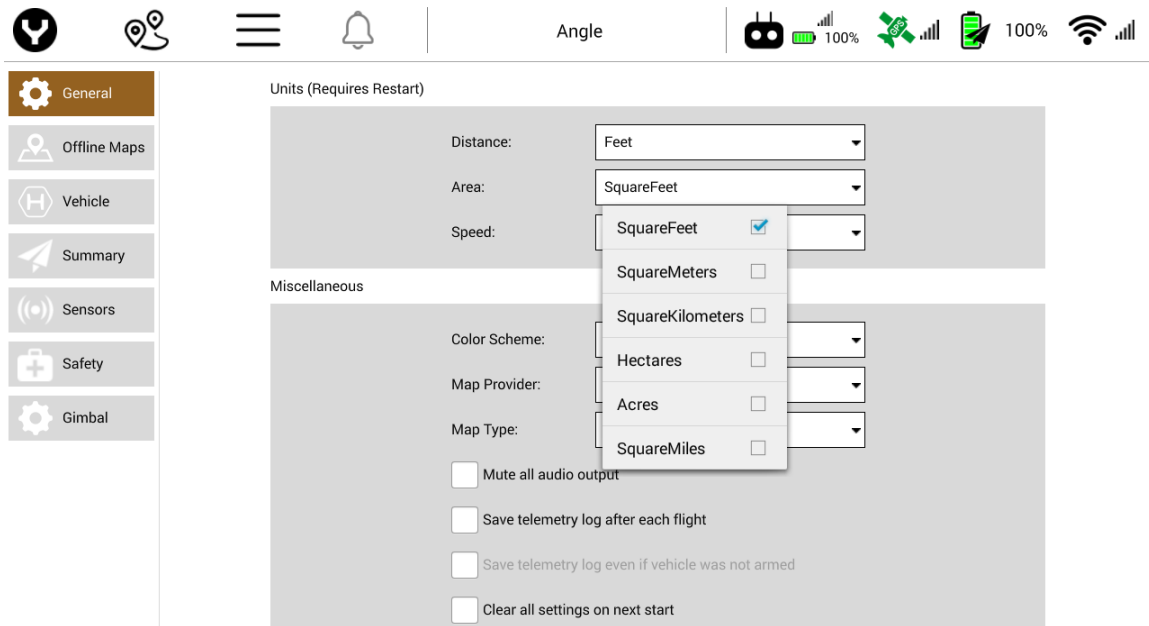

SPEED

The Speed drop menu allows the Pilot to change display between the following settings:

- Feet/second
- Meters/second
- Miles/hour
- Kilometers/hour
- Knots

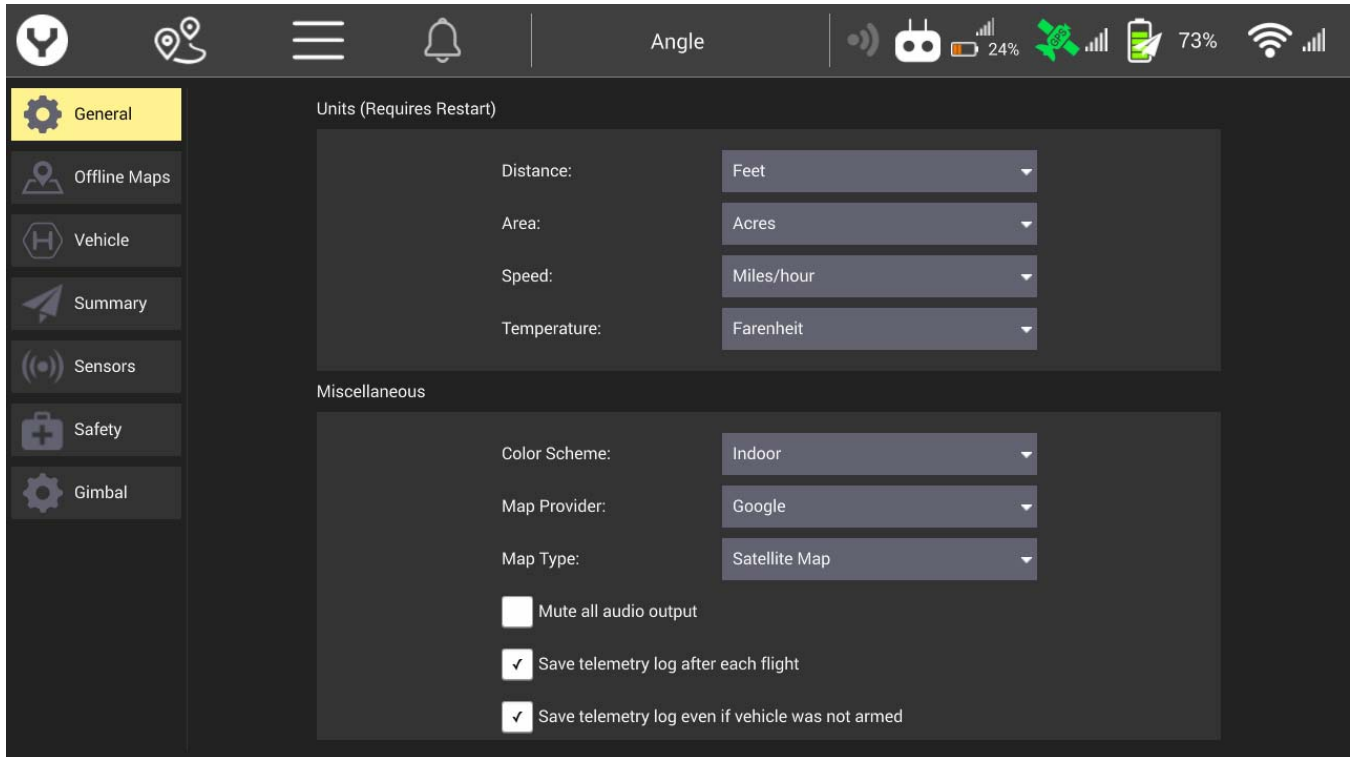

TEMPERATURE

The temperature setting relates to the CGOET camera and how it displays temperature. Users may designate Celcius or Fahrenheit display settings.

MISCELLANEOUS

The Misc. menu allows the Pilot to change the settings of the ST16S and H520. The following options are available: Color Scheme, Map Provider, Map Type, Mute, Save Telemetry Log, Clear All Settings, Announce Battery Low, and Default Mission Altitude.

Color Scheme

The Color Scheme drop down menu allows the Pilot to change between the following settings:

- Indoor (dark theme)
- Outdoor (light theme)

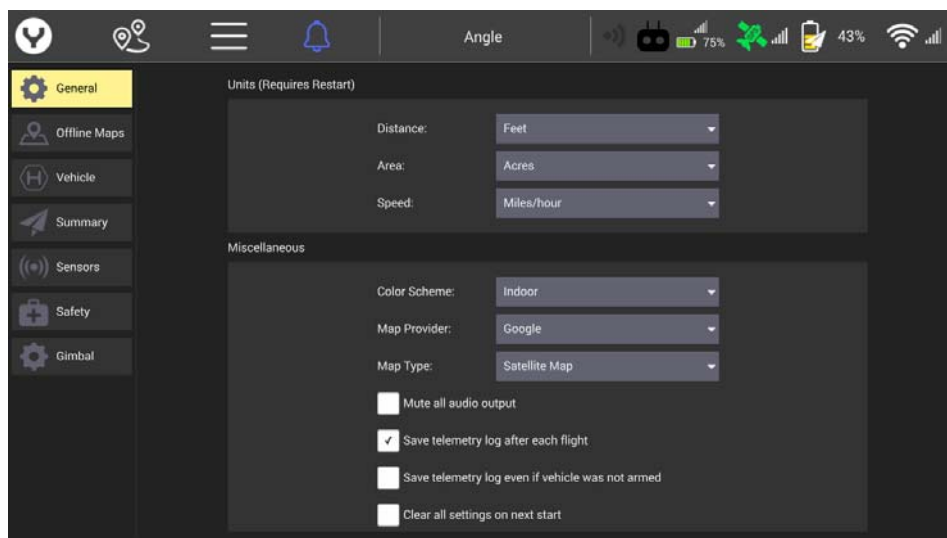
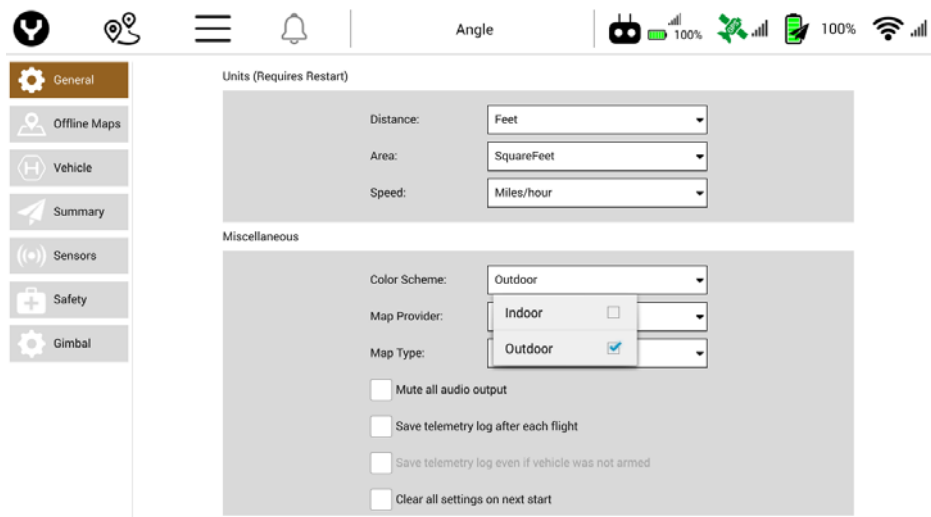

“Indoor” display properties

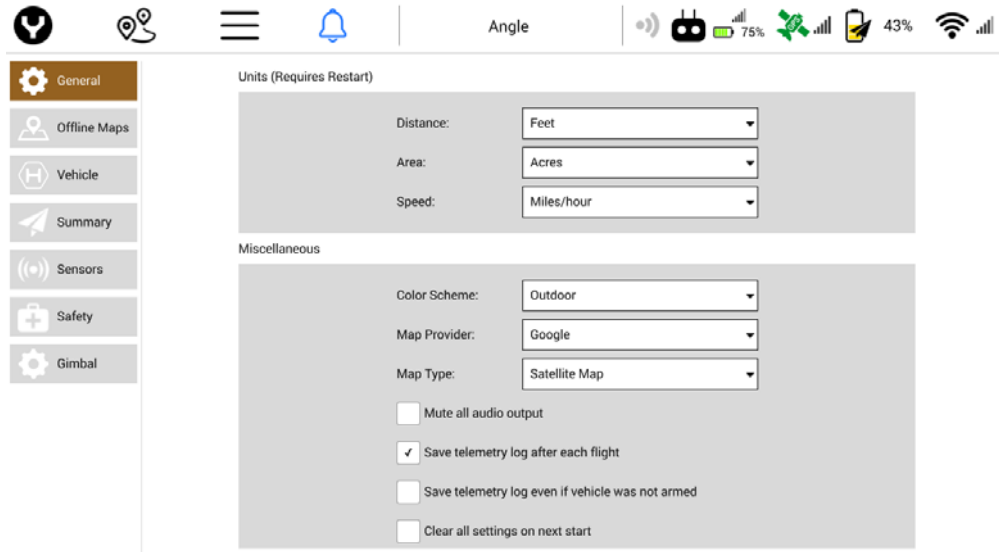

“Outdoor” display properties

The “Outdoor” view does have a slightly higher battery consumption, while allowing pilots to more clearly see data on the screen.

Map Provider

The Map Provider drop down menu allows the Pilot to change the Map overlay on the ST16S Home Screen and Mission Planner menu. The Pilot can choose between, Bing, Google, Statkart, Eniro, or Esri map tiles.

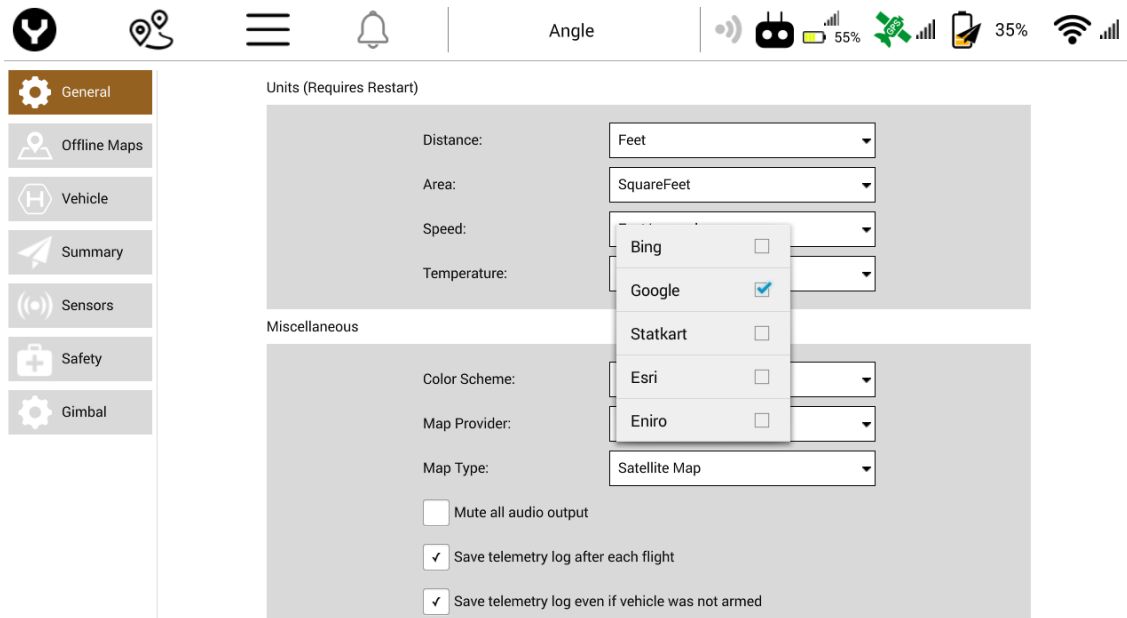

Map Type

The map type menu enables changing between Map Types for the Map overlay in the ST16S and the Mission Planner menus: Street Map, Satellite Map or Terrain Map.

Mute

Mute will disable all audio on the ST16S and prevent audio warnings and advisory messages from being spoken. Muting the audio is valuable when shooting wildlife or working in areas where audio may be a distraction.

Save Telemetry Log After Each Flight

The default for this option is **enabled**. When checked, telemetry log recording will be enabled. Uncheck this option to disable saving telemetry logs to the ST16S to save bandwidth and internal storage. It is recommended that this setting remain enabled in the event of incident. Service personnel will be able to “read” the flight and better understand what may cause system failure or pilot error. Check your organization’s policy/operations manual for guidance.

Save Telemetry Log Even If Aircraft Was Not Armed

When this is checked, telemetry log recording will begin once the H520 is turned on and connected to the ST16S. When unchecked, telemetry recording will not begin until the H520 is armed. Logs are stored to the local ST16 memory and can be accessed by the “Export Data button” under Aircraft settings.

Clear All Settings On Next Start

Checking this box resets the ST16S and H520 to factory default settings at the next restart. Using this option will clear all applied settings and requires a restart to restore default settings.

Announce Battery Lower Than

This setting allows the Pilot to set percentage (%) at which the low battery alarm will be triggered. Yuneec recommends this remain at the default warning setting.

Default Mission Altitude

Default Mission Altitude allows the Pilot to set the default Waypoint and Survey Grid mission altitude for Mission planner mode. To set the Default Mission Altitude, type in the desired Default altitude. *This altitude will be used if no altitude is set for a given waypoint during a mission plan.*

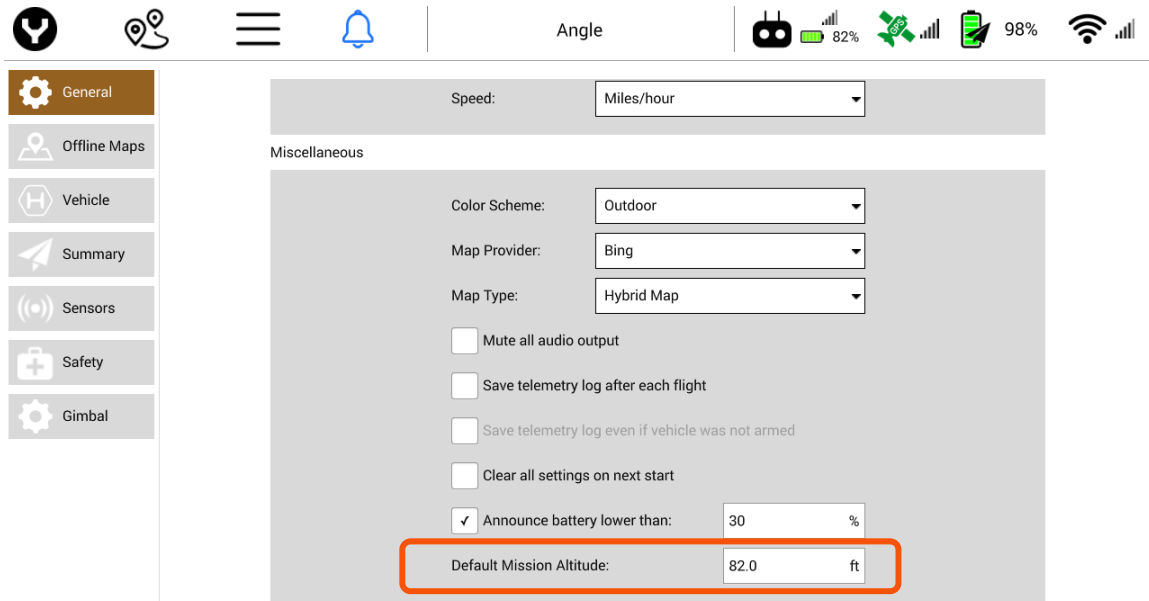

DataPilot™ Version

The current installed version of DataPilot™ will be shown here. It is highly advised to install the most current versions of Firmware to ensure proper operation of the H520 and ST16S. This can be accomplished via UpdatePilot or manually checking the Yuneec Commercial website for updates.

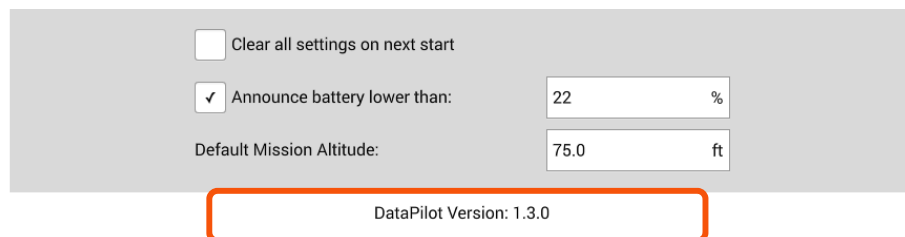

OFFLINE MAPS

Offline Maps allows the Pilot to download and save map tiles of mission areas. Downloading Offline Maps requires a WiFi connection to the Internet to access the map provider download servers. Downloading Offline Maps allows the Pilot to use map tiles in Mission Planner mode to visually assess the location of the mission flight area. It is highly encouraged to download Offline maps at an office/home location due to map tile sizes. Offline Maps can also be downloaded via mobile hotspot in the mission area if desired.

Add New Set

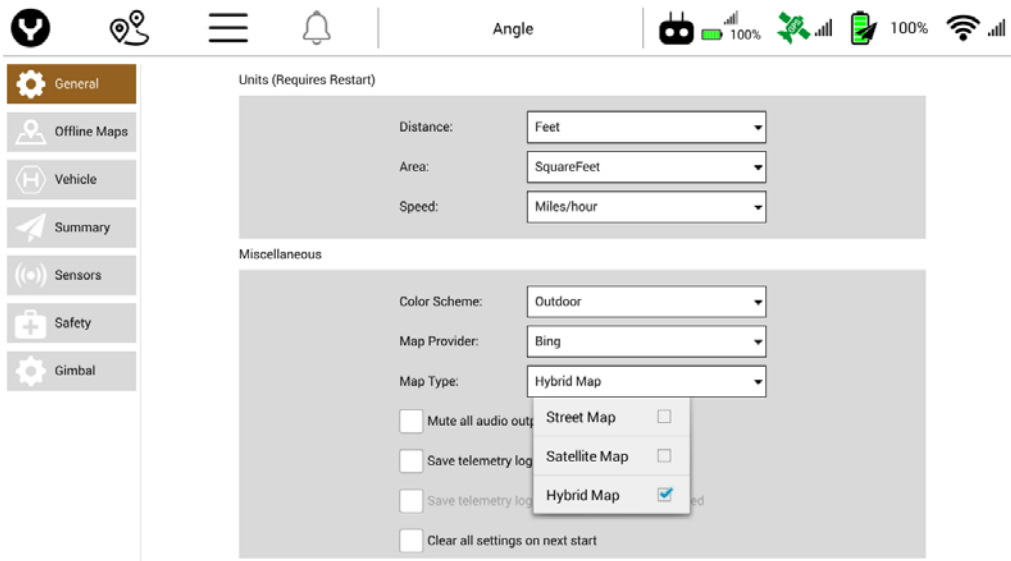

Tap the Add New Set soft key (ensure the ST16S is connected to a WiFi network with Internet access). Tap and drag the map until the desired mission area (depending on the Internet connection speed and size of the area, map tiles might take a few moments to appear) is displayed. To resize the map tiles, pinch or expand two fingers on the screen. The two rectangles on the left of the screen will show the Minimum zoom level and the Maximum zoom level. Using the right menu, the Pilot can name the map tile set using the custom text box. Using the drop down menu, the Pilot can change between the following Maps:

- Google Street Map
- Google Satellite Map
- Google Terrain Map
- Bing Street Map
- Bing Satellite Map
- Bing Hybrid Map
- Esri Street Map
- Esri Satellite Map
- Esri Terrain Map
- Mapbox
- Statkart Satellite Map
- Statkart Terrain Map
- Eniro Satellite Map
- Eniro Terrain Map

If the Mapbox Access Token has been added under the options menu, Mapbox Account maps will be accessible.

Using the slider bars, the Pilot can adjust the Min and Max Zoom levels for the downloaded map tiles. Tile Count indicates the number of map tiles to be downloaded to the ST16S. Est Size indicates the approximate size of the map tile files downloaded to the ST16S. Once the Pilot has the desired map tiles indicated tap the Download button to initiate the downloading of the map tiles. To cancel the New Tile Set, tap the Cancel button.

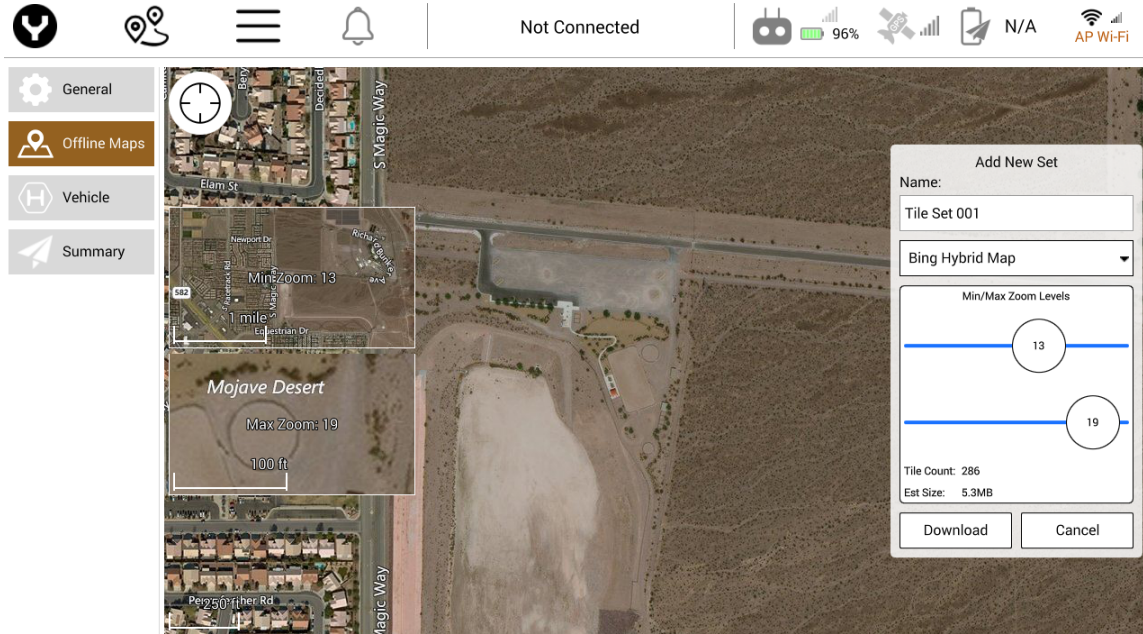

Default Tile Set

Using the Default Tile Set menu, the Pilot can view which map tiles are currently stored on the ST16S. The Pilot can zoom in and out using the pinch method on the map. Displayed on the Default Tile Set is the current size of the Default Tile Set in Megabytes and the current tile count. To delete the current Default Tile Set, tap the Delete button.

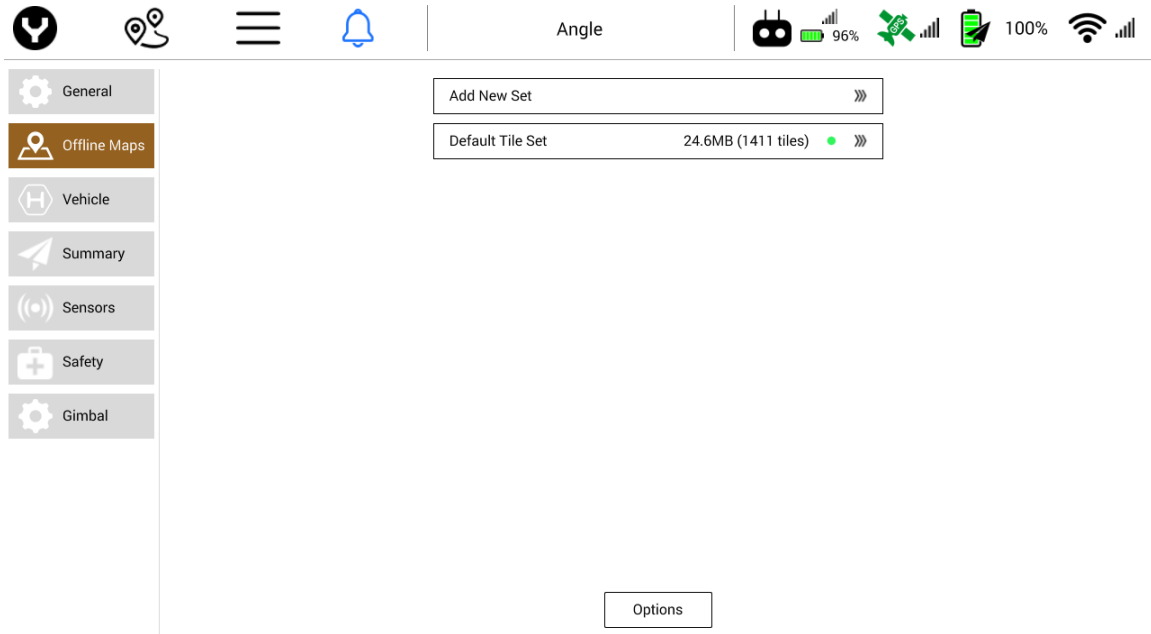

Note: Be aware of highly detailed maps filling internal storage. Check storage space if maps become sluggish or will not save.

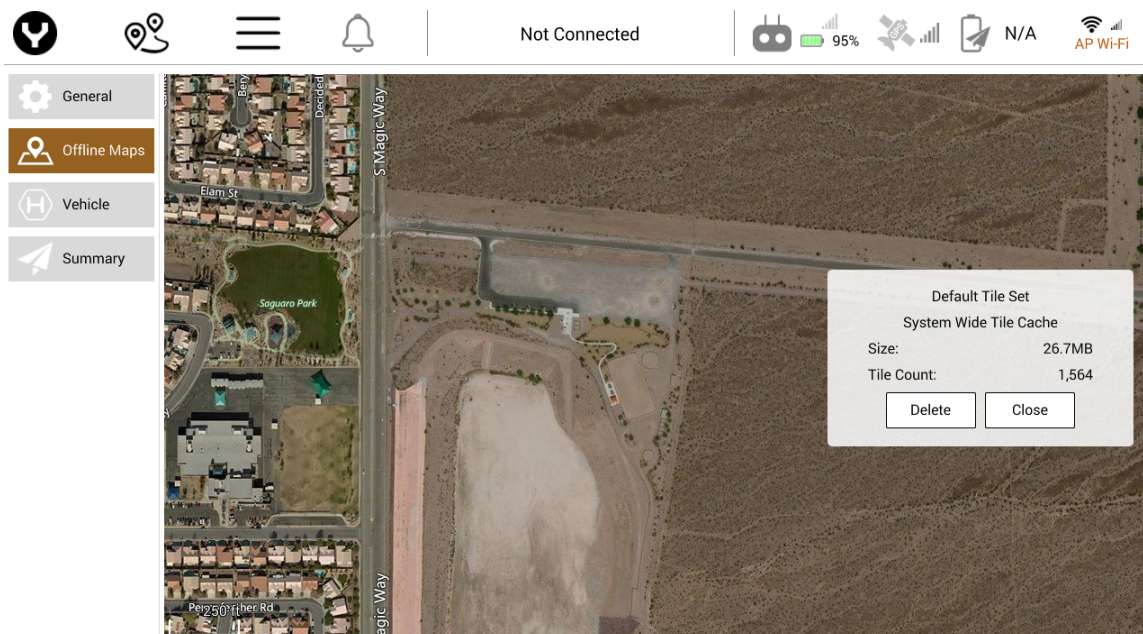

Options

Tap the Options menu to set the following Offline map settings:

- Max Cache Disk Size (MB)

Sets the maximum amount of disk space used to cache tiles while using the maps. Default is set to 1024MB.

- Max Cache Memory Size (MB)

Sets the maximum amount of system memory used to cache tiles while using the maps. Default is set to 16MB.

- Mapbox Access Token

Users can enter their Mapbox token here which allows for the downloads of Mapbox map tile sets. Register for free Mapbox tokens here: <https://www.mapbox.com/signup/>

AIRCRAFT

IMPORT MISSION

Import mission facilitates missions to be transferred from a microSD Card to the ST16S and edited in the Mission Planner Mode. This is useful when transferring missions from another ST16S or from the DataPilot™ desktop application.

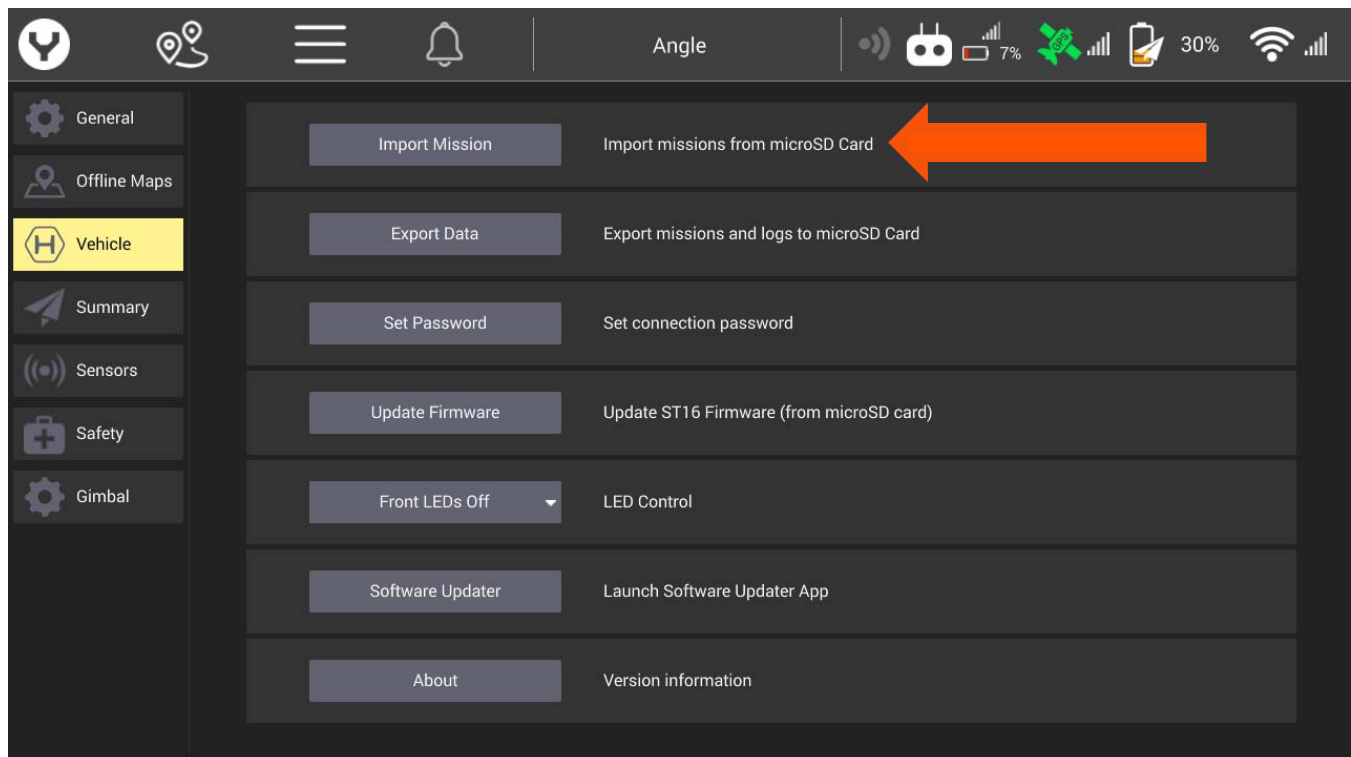

EXPORT DATA

Export Data transfers all the saved missions and telemetry logs from the ST16S to the microSD Card. This feature is for sharing data between ST16S or for debugging issues. These exported data files will be useful in the event of an incident, allowing Yuneec technical support to determine cause of incident.

MANUAL BIND

Manual bind allows the Pilot to bind the ST16S to the H520 without a camera. Power on the H520, tap the Manual Bind button, and flip the H520 upside down. The H520 LEDs will begin flashing yellow on all motors. Now tap the Bind button on the popup window. The ST16S will bind to the H520. This connection may be tested by raising the landing gear while the H520 is upside down.

*Note: The H520 does not provide telemetry data to the ST16S while in manual bind mode. The Pilot will not have the ability to check GPS status, battery status, etc.

SET PASSWORD

Set Password empowers the Pilot or an IT department to change the connection password to the aircraft and camera. Tap the Set Password soft button to open the password change dialog screen. Enter the new password (8-20 characters) then re-enter it in the next box to confirm. Tap “Ok” to set the new password. The aircraft must be restarted and reconnected using the new password.

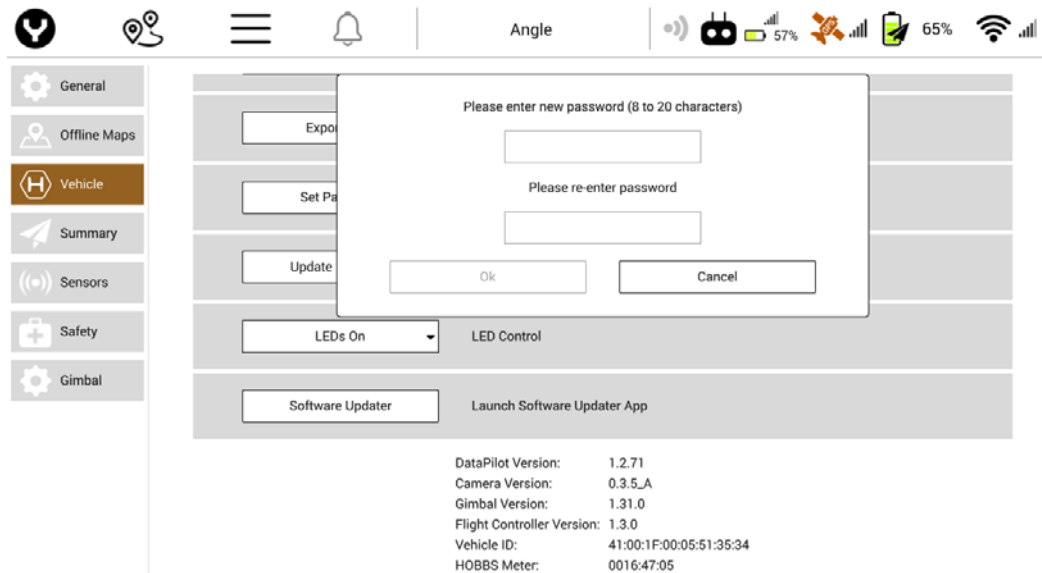

Important Note: It is highly recommended that the aircraft always be recalibrated after each software/firmware update. This is a safety practice to ensure the aircraft is always properly calibrated.



UPDATE FIRMWARE

Update Firmware enables the Pilot to upgrade the ST16S firmware. The file (update.zip) must be present on the root directory of the microSD Card. Yuneec recommends using UpdatePilot™ for updating software. UpdatePilot will auto-update all components of the H520. Yuneec UpdatePilot™ may be found at play.google.com

Updates may be manually installed using a microSD card. Download firmware from the <http://commercial.yuneec.com/comm-downloads-h520> website and copy to a microSD card.

Insert the microSD card to the mounted camera with the aircraft powered down/battery removed.

Turn on the aircraft, and allow it to boot from the card. The light on the front of the camera will flash purple and the lights on the motor arms will flash on/off. Once the camera light flashes green and the motor arm/navigation lights turn to a normal state, the aircraft will reboot. The camera light will be solid green, indicating readiness for flight. Autopilot, camera, and gimbal software have been updated.

It is recommended that the aircraft be re-calibrated following any update.

LED CONTROL

This setting allows the pilot to set controls over which aircraft LED's are enabled/disabled. Pilots may choose to have all LED's on, Front LED's off, or all LED's off. When the front LEDs are disabled the right/left (nose) LEDs are turned off, allowing the pilot to easily identify the direction the nose is facing in dark environments.

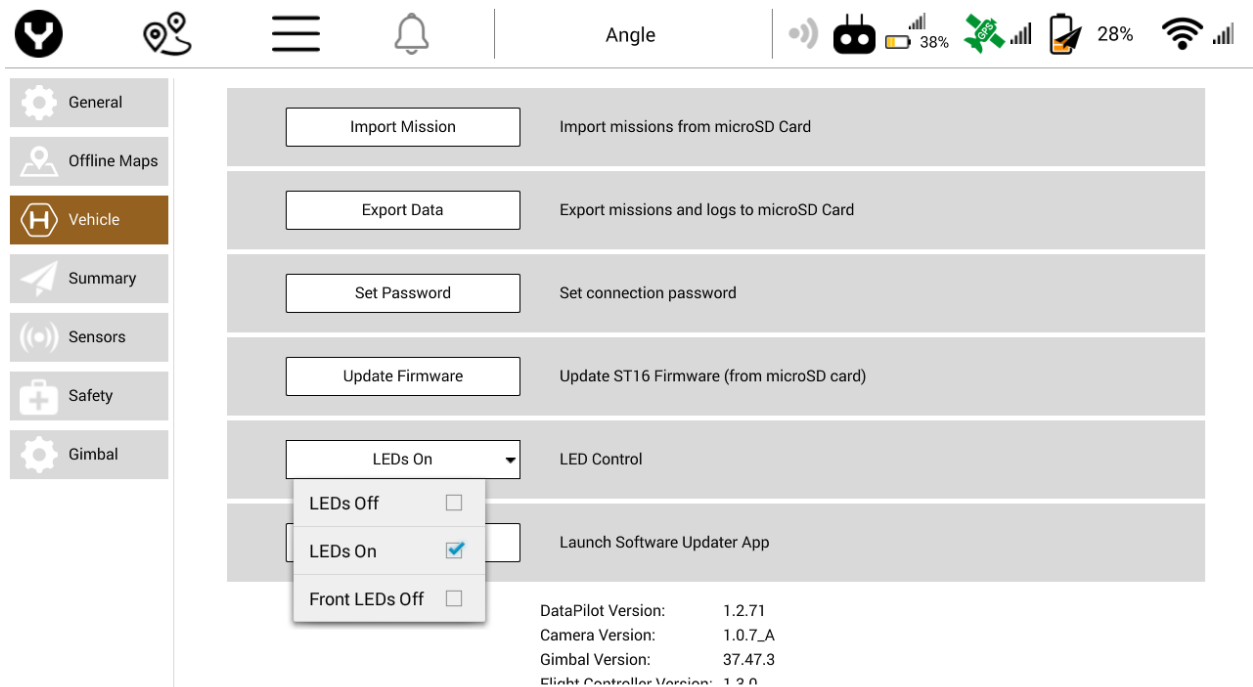

SOFTWARE UPDATER (UPDATEPILOT™)

When the Software Updater softkey is pressed, the Yunee UpdatePilot application will launch, and will attempt to connect to the last-known WiFi connection. If the aircraft is not registered, UpdatePilot will ask the user if they would like to register the aircraft.

Tap the large round button in the application to begin the update check process. This is the most efficient means of updating the H520 Autopilot, DataPilot™, mounted camera, and gimbal. However, users may also wish to manually update various components.

DataPilot™ may be updated through the microSD card port on the ST16S. Download the DataPilot™ application from play.google.com and store on the microSD card. Place the microSD card in the ST16S.

In the ST16S settings panel, browse FILE MANAGER | External SD card, and locate the DataPilot™ install icon.

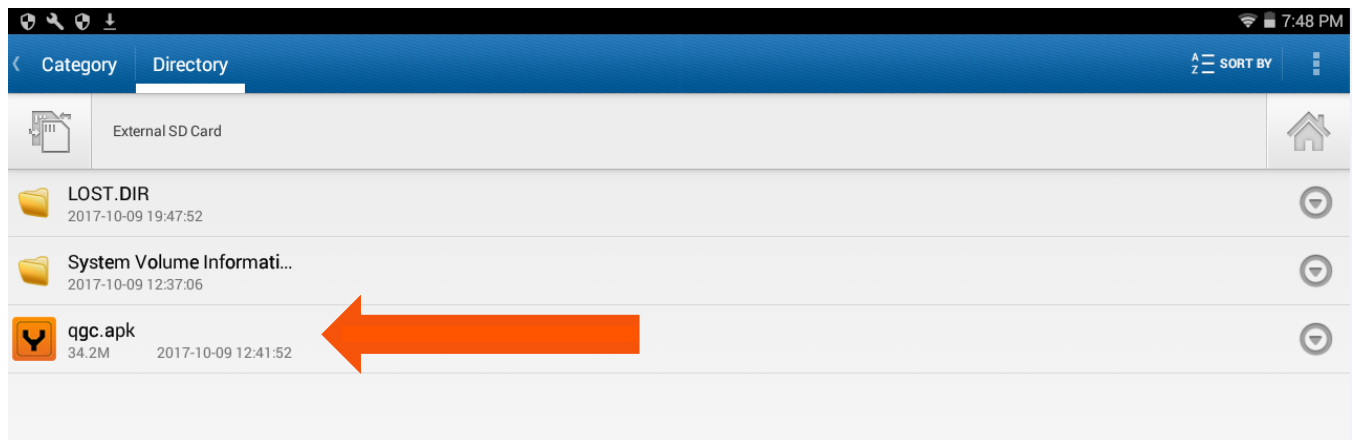

Tap the “Install” option, and DataPilot™ will update. The ST16S does not require rebooting following the update.

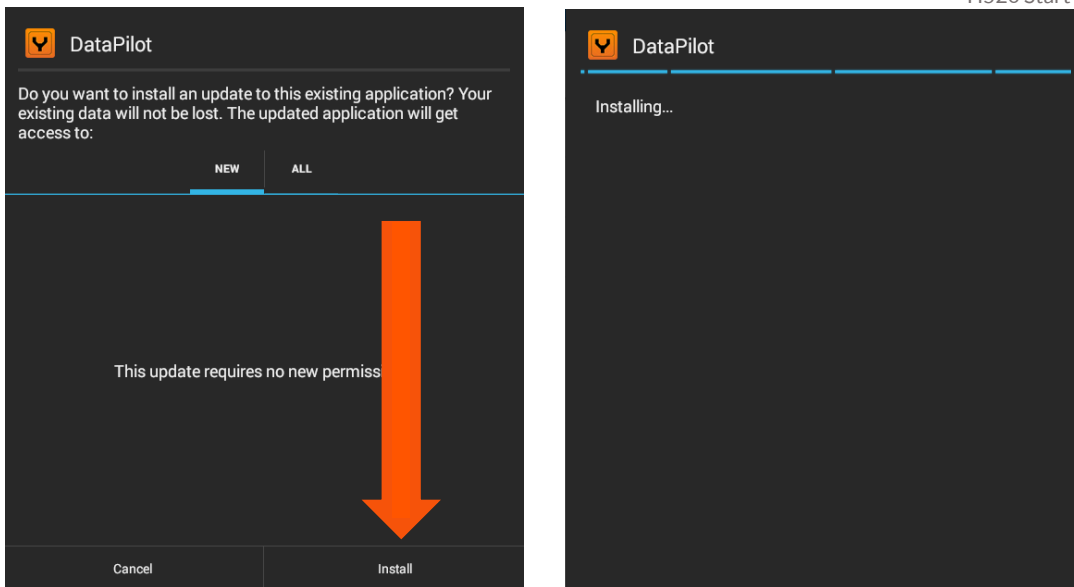

Tap the "OPEN" button in the dialog to start the new version of DataPilot™.

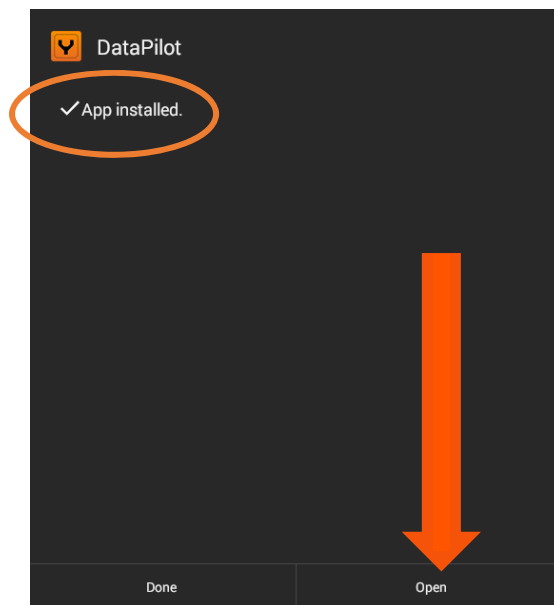

VERSIONS

Displayed on the bottom of the Aircraft Menu Settings are the current versions of the following Firmware Versions: DataPilot™, Camera, Gimbal, and Flight Controller. It is highly recommended to install the most current versions of Firmware to ensure proper operation of the H520 and ST16S (refer to AC107.7.2).

Aircraft ID

An unique ID in the form of 8 pairs of HEX digits separate by colons is displayed for the connected aircraft, i.e. xx:xx:xx:xx:yy:yy:yy:yy

The aircraft ID is required for some upgrade and security uses and OTA updates.

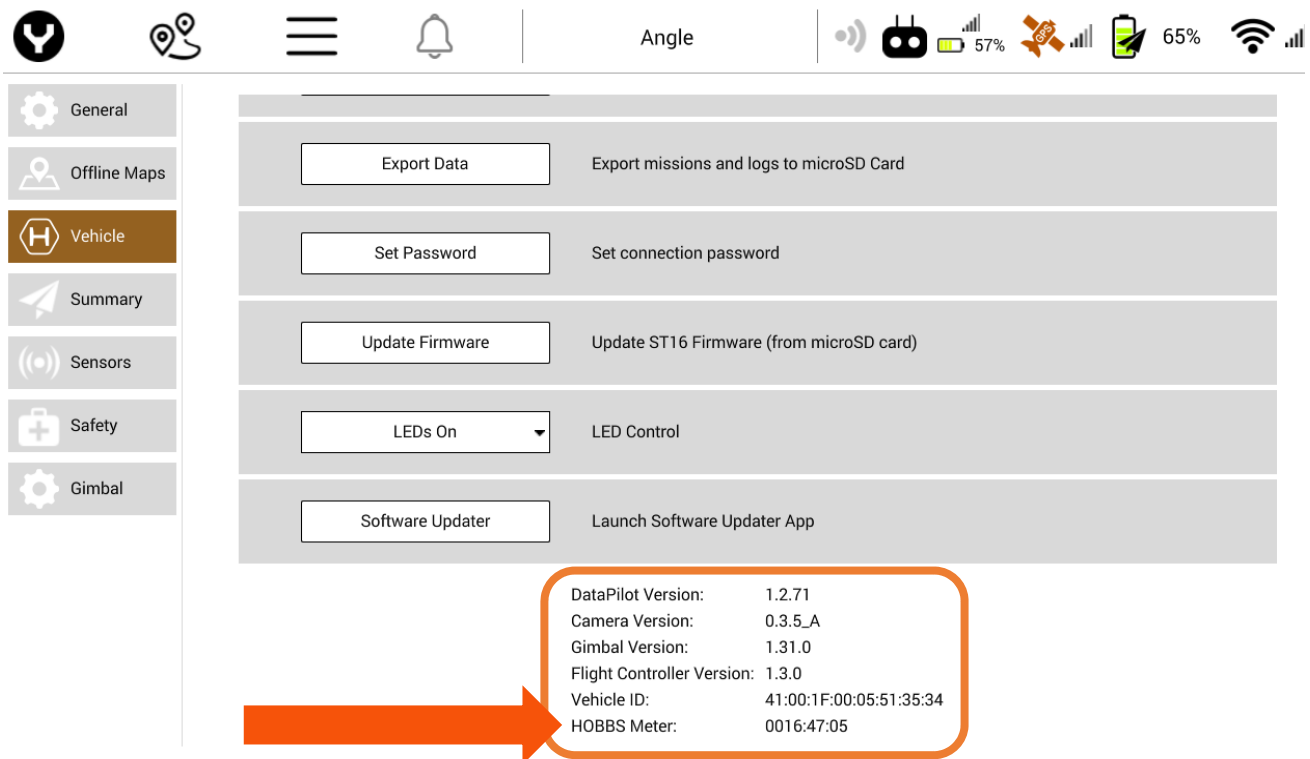

A HOBBS meter is found at the bottom of the versions window; this provides information related to total aircraft flight time /cycles, and helps provide guidance for maintenance hours as defined in the Yuneec H520 maintenance guide as per FAR 43 and 91. The Hobbs meter is a genericized trademark for devices used in aviation to measure the time that an aircraft is in use.

IMPORTING OTHER MISSION TYPES

DataPilot™ may also import .kml missions from Google Earth. Files may be imported either via the DesktopPlanner or from missions transferred from USB or MicroSD to the Mission Folder on the ST16 or the MicroSD card.

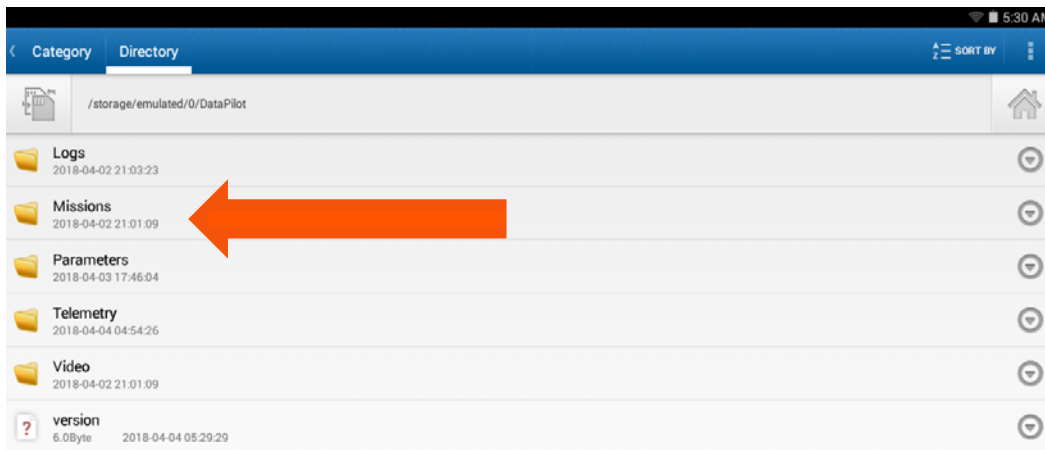

This feature allows mission areas to be planned in applications such as Google Earth, exported as a .kml file, and imported to DataPilot, where a mission plan is output to the aircraft.

.kml files are able to describe:

- A polygon for the Survey area
- A polygon for a Structure Scan
- A polyline for a Corridor Scan

In Google Earth, a mission may be displayed with 3D views, coverage area, and altitude.

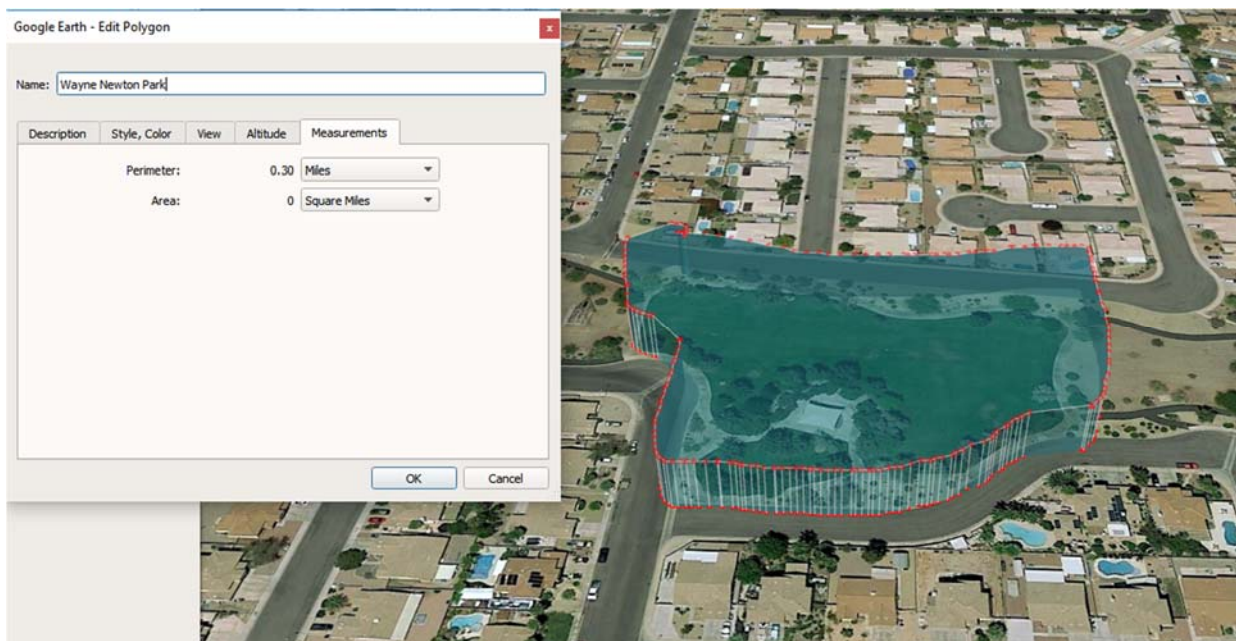

Once transferred to DataPilot™, the mission will display in a flat, 2D display identical to missions generated in DataPilot™.



CREATING A NON-NADIR SURVEY

Sometimes cameras need to fly very close to objects of interest and a nadir mission may not allow for full coverage. In these instances, users may bypass the auto-nadir position of the camera during a survey.

This is accomplished by inserting a Waypoint *prior* to inserting a survey grid. Set the gimbal pitch in the Waypoint Properties, and the Survey Grid will maintain the set gimbal pitch value throughout the mission. This is particularly useful if oblique angles are difficult to obtain due to space constraints.



SUMMARY

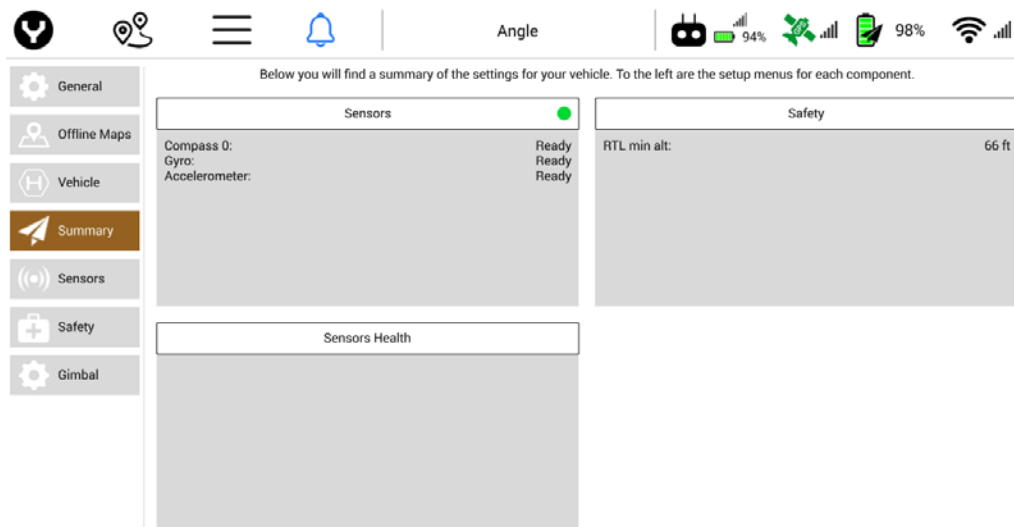

SENSORS

Displayed in the Sensors window is the status of the Compass, Gyro, and Accelerometer. A Ready status (green dot) indicates the H520 is ready to operate. A Fail status (red dots) indicates the affected sensor needs to be calibrated (see the [Calibration](#) section for further information).

SAFETY

Displayed in the Safety window is the value of the Return to Launch minimum altitude setting (RTL min alt). Yuneec recommends checking this altitude at each new flight location to ensure best safety practices.

SENSORS HEALTH

Displayed in the Sensors Health window is the status of the H520 sensors. A 'Not Ready' status will be shown for all sensors that need to be checked (gyro, accelerometer, barometer, GPS, etc.). It is equivalent to a warning condition, and not a critical issue.

It is important to calibrate the aircraft from time to time. Yuneec requires the aircraft compass be calibrated any time the aircraft is further than 5 miles from any previous calibration.

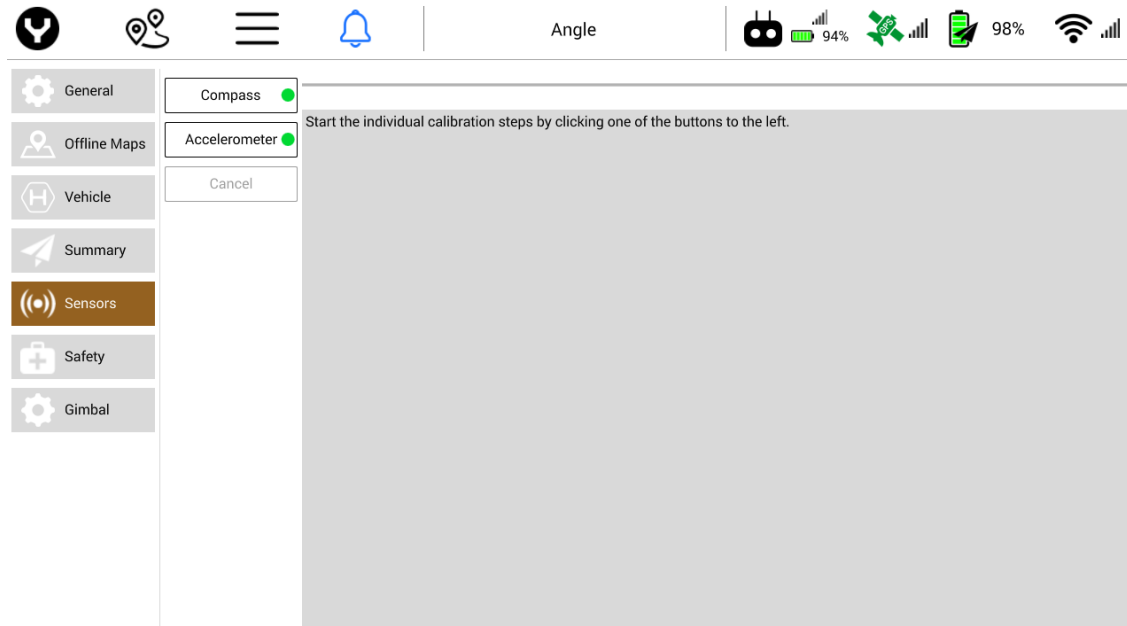

SENSORS

COMPASS

A green dot next to the compass indicates the H520 has been calibrated. A red dot indicates the compass needs to be calibrated.

ACCELEROMETER

A green dot next to the accelerometer indicates the H520 has been calibrated. A red dot indicates the Accelerometer needs to be calibrated.

CALIBRATIONS

Compass

To calibrate the compass, tap the Compass soft key, then tap OK in the pop-up window on the right. A graphical grid will display with six boxes. Each box indicates what is required to calibrate the compass. Pick up the H520 by the two arms, with green dots, as close to the Arm joints as possible. Rotate the H520 in the direction indicated in the box highlighted in yellow. Using the Arrow in the box to point towards the front of the H520 (the front has the two sonar eyes). Rotate the H520 until the H520 beeps. Continue doing the same for the next box highlighted in yellow. Upon successful completion of the Compass calibration, the ST16S will return to the Sensors Setting Menu and a green dot will be displayed next

compass. A compass calibration fail will be indicated by all six arm lights on the H520 blinking red. If the calibration fails, try again after moving the aircraft away from any metallic objects nearby.

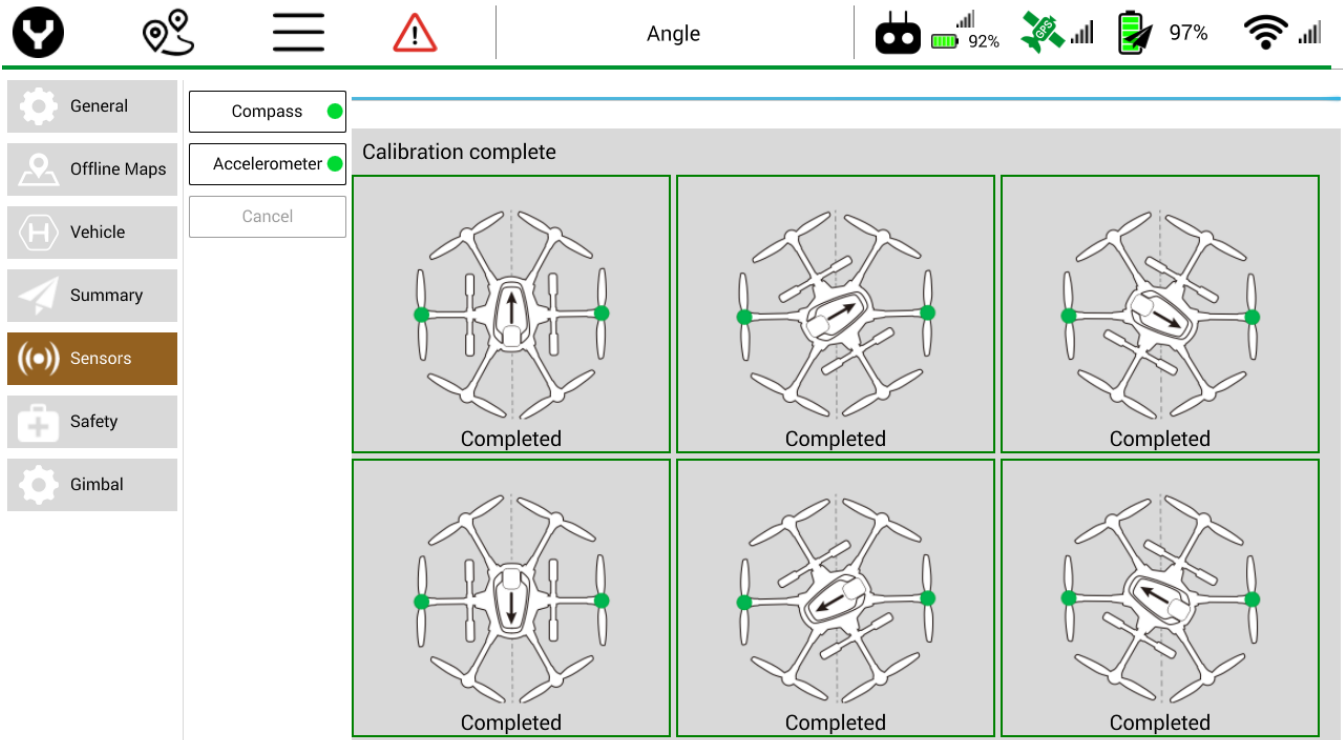

Accelerometer

To calibrate the Accelerometer, tap the Accelerometer soft key and tap OK on the right side of the screen. A six-box grid will appear with the H520 in different positions. Place the H520 on the ground as shown in the highlighted box. After each position, the H520 will give an audible tone and the highlight box on the ST16S will change to the next position. Upon a successful completion of accelerometer calibration, a green dot will appear next to the Accelerometer setting. A failed calibration will be indicated on the H520 by all six arm lights flashing red. If fail, try again, being sure to not move the aircraft during calibration.

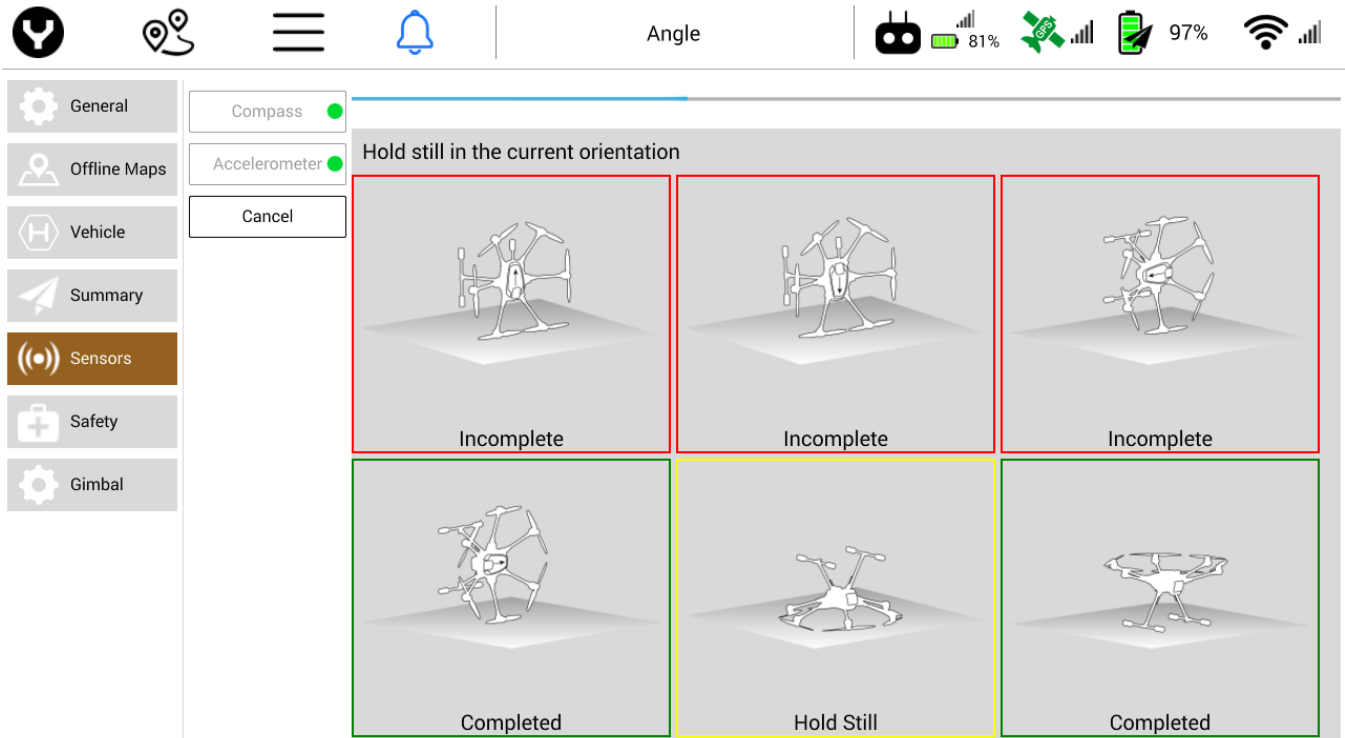

SAFETY

GEOFENCE FAILSAFE TRIGGER

Action on Breach

Using the Action on Breach drop down menu the pilot can adjust the following actions

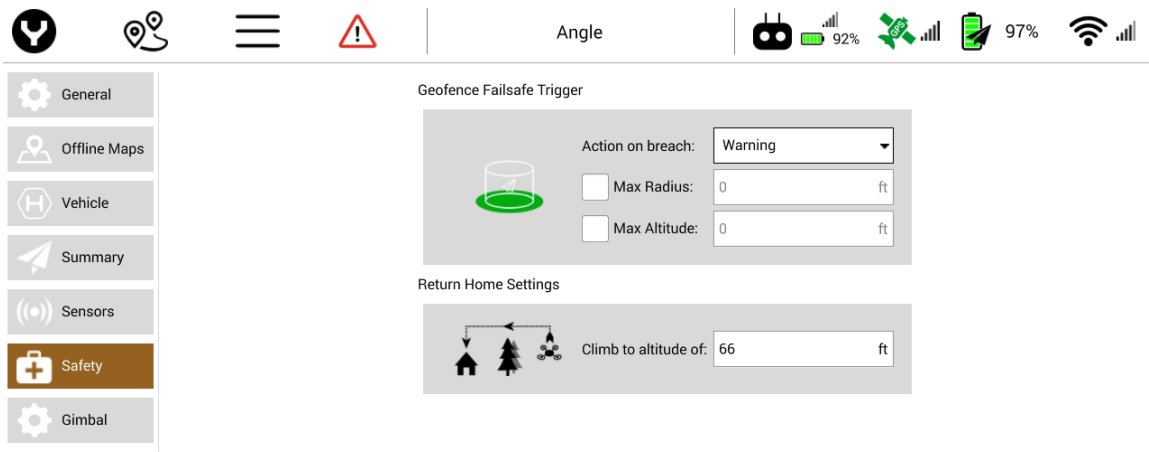

- **Warning** – Provides an audible warning when the Geofence is breached.
- **None** – No actions are taken when the Geofence is breached.
- **Return to Launch** – Return the H520 to the launch point following a Geofence breach.
- **Loiter** – Causes the H520 to loiter/hover in place following a Geofence breach. The pilot may manually continue flight after moving beneath/away from the Geofence breach area.

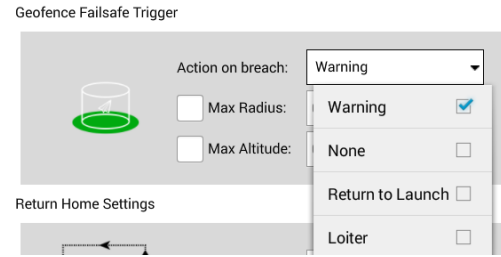

Warning and Loiter are the most common settings for this function. Consult the local requirements or aviation agency to determine if there is a required action on GeoFence breach.

Max Radius

Sets the maximum radius of the geofence relative to the launch position.

Max Radius: 0 ft

Max Altitude

Sets the maximum altitude of the geofence relative to the launch altitude.

Max Altitude: 0 ft

RETURN TO HOME SETTINGS

Using the Return to Home settings menu, the Pilot can set the altitude of the H520 upon executing a RTL. This setting is useful for avoiding any trees or obstacles on the return path to home. **Ensure this setting is checked at any new area being surveyed/flown.**

Return Home Settings

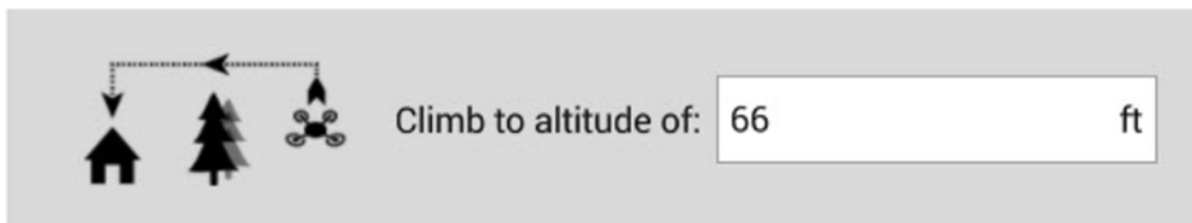

GIMBAL

START GIMBAL CALIBRATION

It is highly encouraged to calibrate all camera gimbals upon *first use and after firmware updates*. To calibrate the camera gimbal, place the aircraft on a flat and level surface, then tap the Start Gimbal Calibration soft key near the bottom of the screen. The gimbal calibration will begin automatically. This procedure can take several minutes to accomplish. Follow instructions on the ST16S prior to beginning a gimbal calibration.

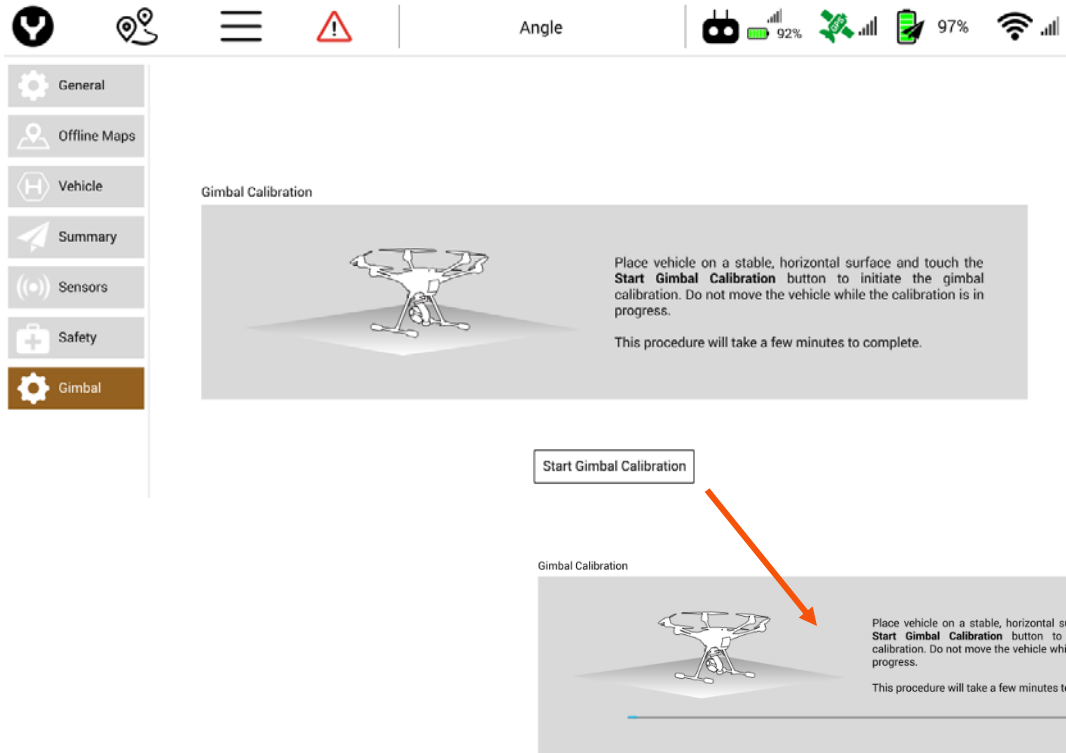

Tip! If the calibration hangs or locks up, tap the gimbal with a slight bump or tap to see if it continues. Otherwise, restart the process.

AUTOMATED FLIGHT MODES

The H520 is designed for automated flight, scanning, mapping, surveying, and other consistent-flight modes for precision image capture and post processing preparation. There are multiple features for automated flight.

Goto Location

The most elementary automated feature of the H520 is “Goto Location/Tap to Fly.” After taking off, tap a point on the map on the screen, a slider will open. Slide the control to the right and the aircraft will fly to that location.

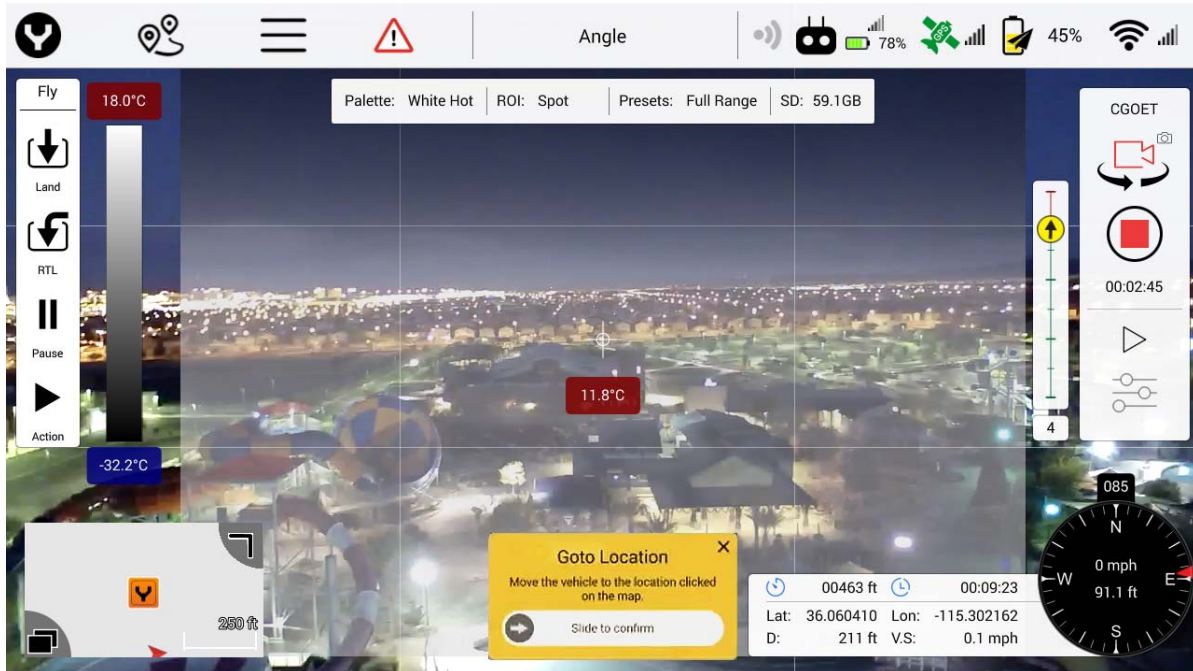

TIP! Check the area around the flight area prior to tapping to fly. There may be obstacles that must be avoided. Caching a map will provide a clear visual of where/how far the aircraft will fly when tapped.

In the event the aircraft must be stopped while traveling to a tapped location, move the controls and the aircraft will immediately respond to control input.

MISSION PLANNING MODE



To enter Mission planning mode, tap the waypoints icon on the top of the DataPilot™ home screen. The PLAN window will open, allowing users to create Waypoint and Survey missions, sync missions between desktop, ST16S, and aircraft, store/recall missions, and Center a mission around a particular point on the ST16S screen.

Active or cached maps may be displayed in this screen (see GENERAL | MAPS screen for options) and missions may be planned on the displayed map.

WAYPOINT NUMBERING

A mission is comprised of mission commands such as capture photo and stop capturing photos that include waypoints as well. Each indicator represents a command and is labeled with a number. The numbering increases by 1 for each subsequent command. For commands which have a lat/lon associated with them, they are placed at its location on the map as a waypoint. For commands which don't have a lat/lon value, they are placed to the right of the last waypoint. Waypoint numbers are not displayed in Survey modes in order to present an unobstructed map view on the multi-function display. However, Survey missions are waypoint missions with DataPilot™ presets assigned to the mission parameters to ensure consistent image capture and accurate lines of flight.

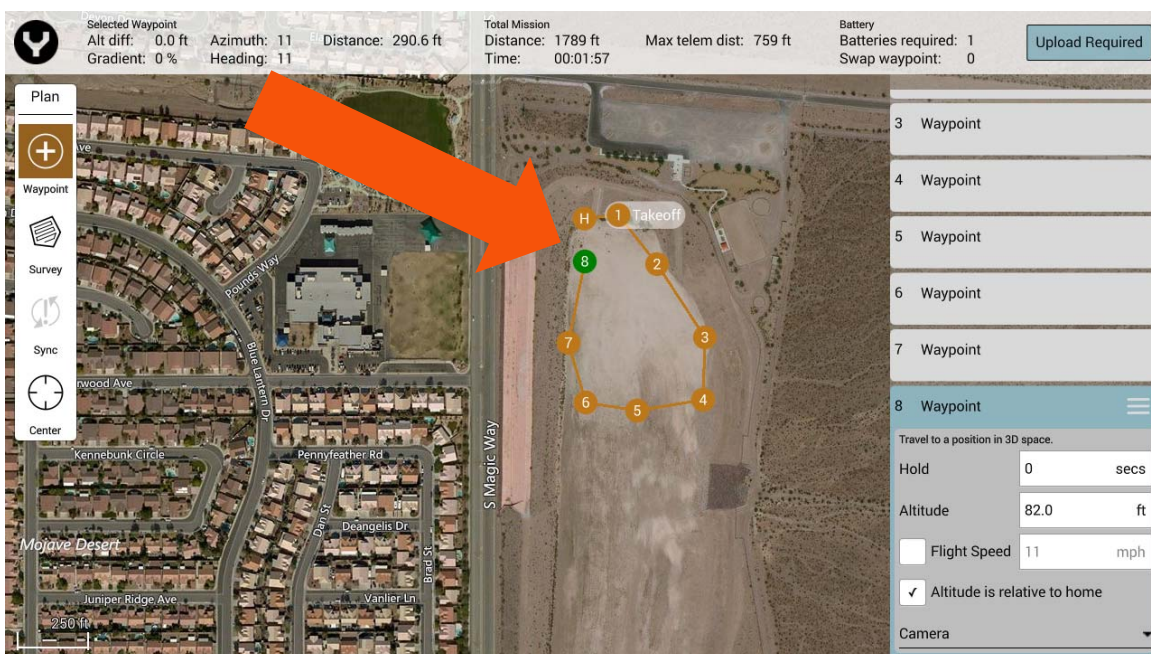
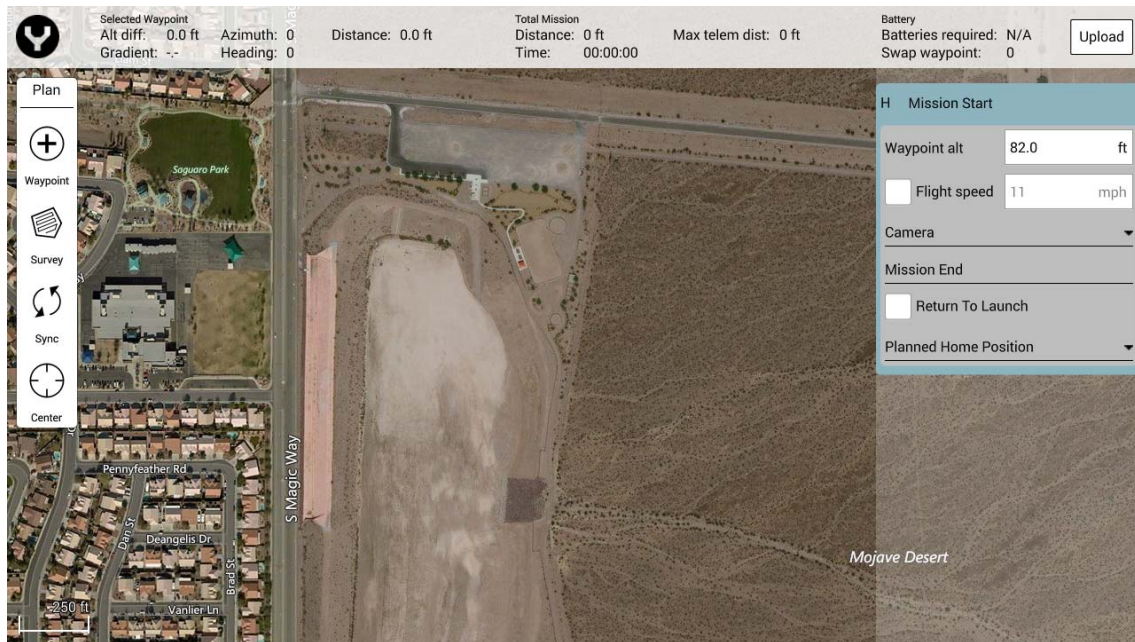

WAYPOINT MODE VS SURVEY MODE

Waypoint mode allows the Pilot to establish a non-gridded flight plan over an area with control points for location, camera, altitude, speed, and camera or aircraft yaw. Each waypoint is separately controlled, enabling the aircraft to ascend, descend, point the camera at an area, speed up/slow down, etc.

SURVEY MODE

Survey mode allows the Pilot to quickly place a survey grid over a desired area. To select a survey grid mission, tap the Survey Icon in the Plan panel. This will place a green survey grid in the middle of the screen over the map. To move the survey grid around the map, hold and drag the white dot in the center of the survey grid. Tapping and dragging a white dot on the outside of the survey grid allows the dimensions of the survey grid to be adjusted. Tapping a '+' dot allows the Pilot to add more white dots to the edge of the survey grid for finer flight paths.

Note: The first placed waypoint will by default be the Takeoff point waypoint. To place another Waypoint, tap on another location on the map. Continue tapping on the map until the desired mission route has been completed.

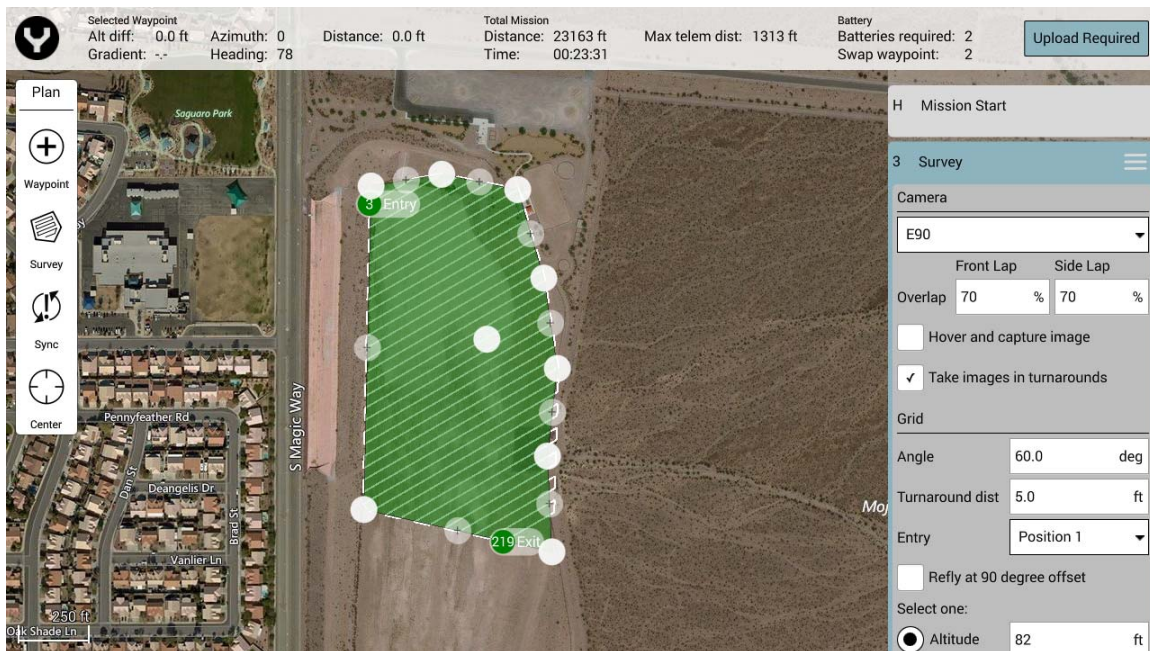

HOME LOCATION

When planning offline, i.e. no known location for the H520, the home position is automatically set to be at an offset position from the first placed waypoint. The home position can be changed by tapping the waypoint and dragging it to a new location. During mission takeoff, the home position is reset to the location of the aircraft, but will not be saved when offline. Yuneec recommends setting the home location for each mission.

ADJUSTING MISSION PARAMETERS

To adjust Mission level parameters, use the menu on the right side of the Mission Planning window.

MISSION START

Mission Start permits the Pilot to adjust the entire mission's Altitude, Flight Speed, Camera Options, Mission End, and Planned Home Position.

- **Waypoint Altitude** - Defaults the Waypoint altitudes to custom value for all dropped waypoints. For Survey items, only the ones with a user-defined altitude setting will be changed. Survey items with ground resolution settings (implicit altitude value) will not be affected.
- **Flight Speed** - Defaults the flight speed for the entire planned mission including survey items.

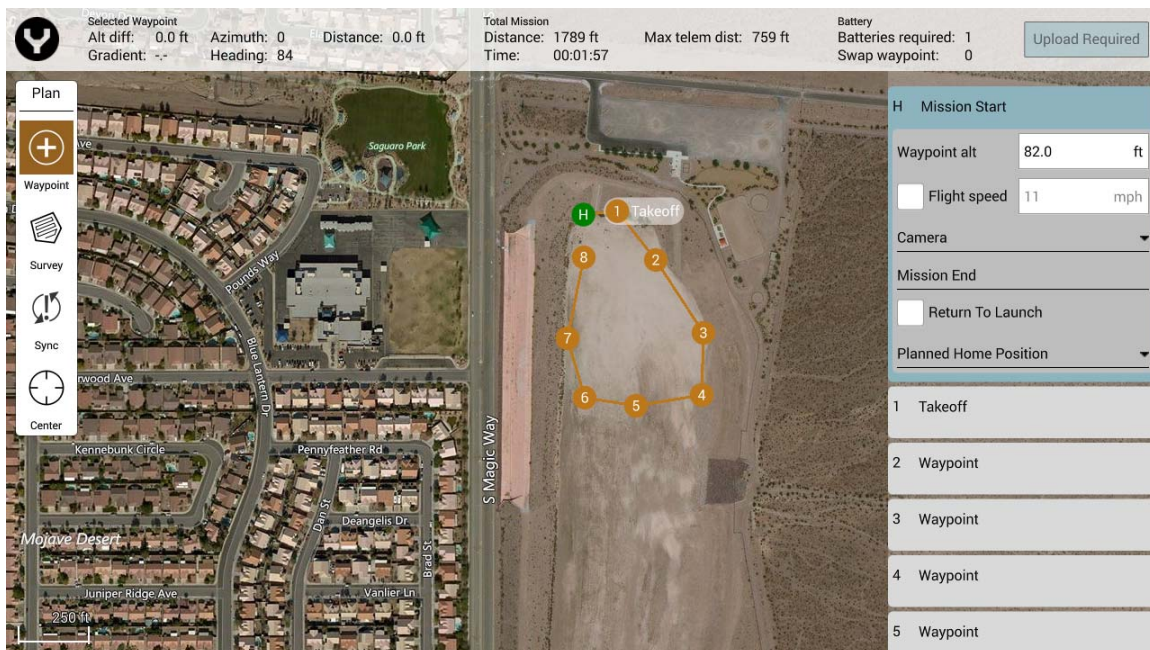

TIP! Flight speed is an important consideration to capturing clear and clean orthomosaics and digital surface models. Ideally, flight is at 4 meters per second/8.5mph (altitude dependent). If images are being captured every 8 meters, the camera is capturing an image every two seconds. High speed can incur blurred images, making stitches less clean.



MISSION END

- **Return to Launch** – Automatic RTL on mission end. This will return the H520 to where it took off/launched.

PLANNED HOME POSITION

- **Altitude** – Sets the home position altitude in Mean Sea Level (MSL). Upon connection to an aircraft, this value will adjust to the actual aircraft altitude.
- **Set Home To Map Center** – Sets the planned home position to the current center of the map display. The home position will be reset to the aircraft position at takeoff.

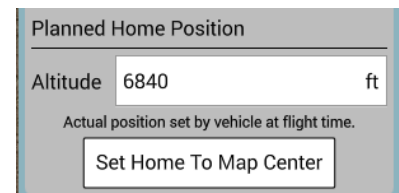

TAKEOFF WAYPOINT

First waypoint placed in Waypoint mode. Takeoff waypoint will navigate the H520 to the specified takeoff point, then head to the first mission waypoint. NOTE: It is highly encouraged to place the takeoff waypoint near the launch/land site.

- **Altitude** – Sets the desired takeoff altitude. Be certain the area is clear of trees, powerlines, power poles, or other vertical obstacles that may interfere with clear waypoint or survey flights.

WAYPOINT

A waypoint is a location on a map indicated as a checkpoint for mission planned flights. Waypoints can be manipulated to cause the H520 to execute different actions at each waypoint. The Pilot can place as many waypoints as required to complete a mission. Each waypoint can have a different altitude, camera settings, gimbal settings, or speed. A waypoint can also be configured to stop the H520 and allow the camera to capture an image at each waypoint (for higher quality, stationary images).

- To select a waypoint, either tap on the waypoint or tap the waypoint number on the right-side menu. The waypoint selected will turn green and expand the options menu. Adjust the Waypoint options using the menu.
- To delete a waypoint, select the waypoint on the right-side menu, tap the three-horizontal line icon, and tap 'delete'.
- To add a waypoint behind another waypoint, tap the 'top' waypoint, tap the three-horizontal line icon, and tap 'insert waypoint', another waypoint will be added after the current waypoint.
- To add a waypoint or survey grid after a waypoint, tap the desired waypoint, tap the three-horizontal line icon, and tap 'insert waypoint' or 'insert survey'.

WAYPOINT SETTINGS

- **Hold-** Checking the Hold box in waypoint settings, will cause the H520 to fly to the waypoint and hover for the indicated amount of time. After the elapsed time the H520 will move to the next waypoint.
- **Altitude-** Use the Altitude box to set required altitude for the selected waypoint. H520 will climb to the indicated altitude once reaching the waypoint.

Note: Ensure the area near the waypoint is clear of obstacles.

- **Flight Speed-** This field sets the flight speed from the current waypoint to the next waypoint. Example: Moving from Waypoint 3 to Waypoint 4 requires a 25 foot gain in altitude, adding 25 feet to the mission altitude in Waypoint 3 will cause the H520 to gain 25 feet at Waypoint 3 before moving to Waypoint 4.
- **Altitude is relative to home-** Used to indicate the currently selected waypoint altitude is relative to the Above Ground Level (AGL) altitude of the Home/Take-off location. By checking Relative to Home box all altitude calculations for the current waypoint will be conducted by adding AGL to Mean Sea Level (MSL).

Example: Home is at a MSL altitude of 1900 feet, the mission is planned at 75 feet. DataPilot™ will automatically calculate the mission flight altitude of 1975 Feet MSL.

CAMERA

Action

- **No Change** – Camera maintains its current mode/settings.
- **Take Photo** – Captures a photo at the current position.
- **Take Photos (Time)** – Captures photos over a set time interval.
- **Take Photos (Distance)** – Captures photos over a set distance travelled.
- **Stop Taking Photos** – Stops the camera from taking photos.
- **Start Recording Video** – Begins video recording.
- **Stop Recording Video** – Stops video recording.
- **Gimbal** - Adjust the camera pitch and yaw at the currently selected Waypoint. To adjust pitch select a value between 0° (flat to the ground) and 90° (straight down). To adjust the yaw select a value between -180° (left of the airframe centerline) and 180° (right of the airframe centerline).

0° to 90° → Right of H520 centerline to full right

91° to 180° → Full right to full rear

0° to -90° → Left of H520 centerline to full left

-91° to -180° → Full left to full rear

Camera position/yaw is relative to the nose-forward flight direction of the H520, and is indicated by white quarter-circle indicators, allowing the mission controller or pilot to determine what the camera will view during a waypoint mission flight (Surveys always point straight down for nadir photos).

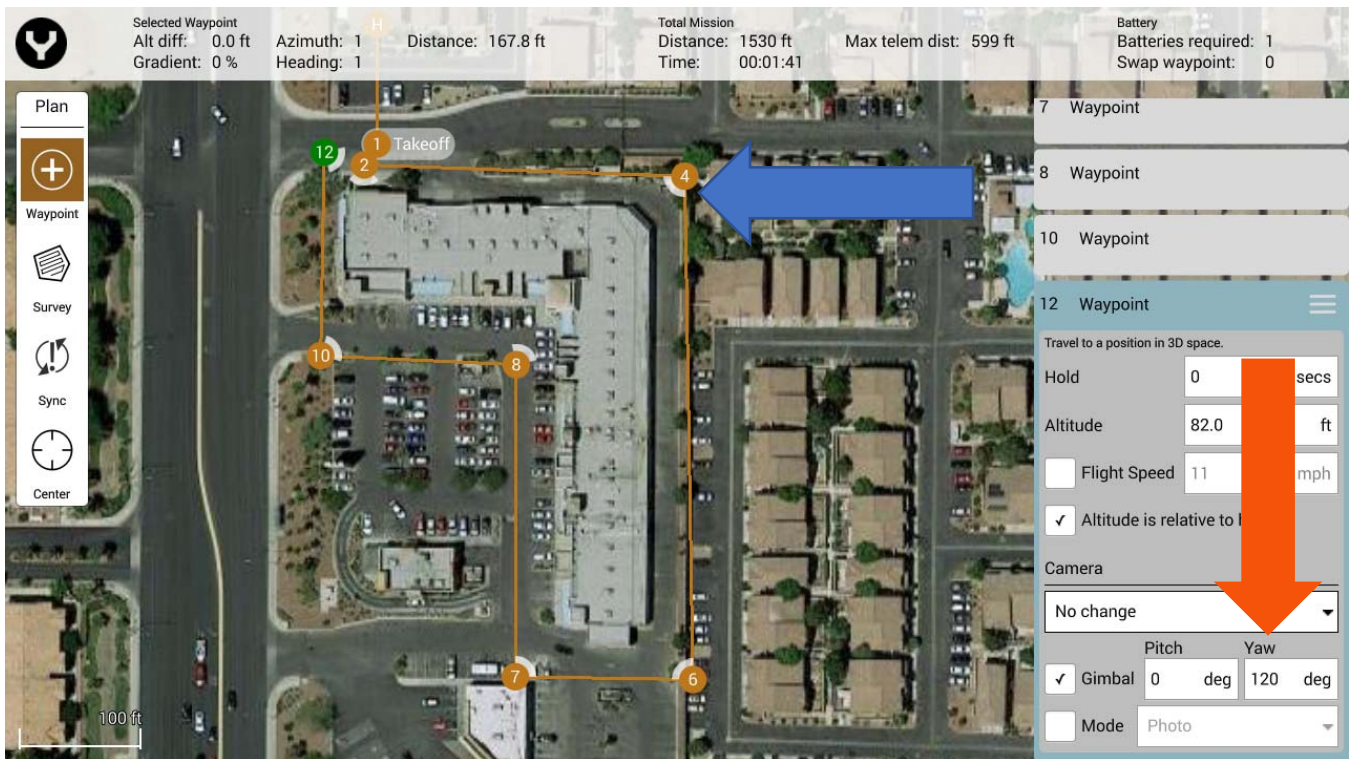

Mode

Sets the mode of the camera to either capture photos, videos, or surveys.

- **Photo** - Sets the camera to photo mode.
- **Video** – Sets the camera to video mode.
- **Survey** - Sets the camera to survey mode, i.e. photo mode with camera settings of AE mode and Unprocessed color mode.

SURVEY GRID

A survey grid is a mission plan allowing the Pilot to plan an automated flight over an area. This automated flight can include images or video of the target area. Survey grids can be flown in a straight-line or a cross-hatch grid. A straight-line grid creates a single pass in a lawnmower pattern through the target area. A cross-hatch grid creates a second pass which is perpendicular to the first pass over the target area. This is useful for 3D modelling which requires better coverage of the scan area.

Note: Concave shaped polygons are not supported. Please use convex polygonal areas. If an obstacle exists in a concave area, assure that altitude is sufficient to avoid the obstacle.

SURVEY GRID MENU SETTINGS

- **Camera** – Select the current installed camera on the H520.
- **Manual Grid** – no camera specs, allows the user to define the spacing between survey grid lines and angle in survey mission. This is useful in extremely low or high-altitude flights.
- **Custom Camera Grid** – Facilitates specific user-camera specs. Users may adjust the sensor size by height and width, image size height and width by pixel and the focal length of the camera. Best used with non-standard cameras or to create custom image sizes with the CGO series cameras.
- **E90** - Pre-programmed for use with the E90 camera system. Best when used with the E90 camera system.
- **E50** - Pre-programmed for use with the E50 camera system, automatically sets the sensor size, image size and focal length. Best when used with the E50 camera system.
- **CGOET** - Pre-programmed for use with the CGOET for H520 camera system. Best when used with the CGOET for H520 camera system.

OVERLAP

- **Front Overlap** – Creates images with a percentage of each image overlapping to the front of the image. Recommended values of 20%-60%.
- **Side Overlap** – Creates images with a percentage of each image overlapping to the side of the image. Recommended values of 60%-85%.
- **Hover and Capture image** – Stops the H520 at each survey waypoint to capture a steady image of the target area. This is useful in high-wind scenarios, or when ultra-sharp images are required. The aircraft will hover for 4 seconds between point to point movement, enabling the aircraft to stop movement and capture a sharp image. This is particularly useful when mapping in dim/low light.
- **Take Images in Turnarounds** – Take images during the turns into the next grid line.

Note: For stitching 60% front overlap and side overlap is sufficient. For generating digital surface models and orthomosaics up to 85% front overlap and side overlap may be required. Under ideal conditions 75% and 65% are common settings. In high winds, it is recommended to use maximum values for front and side overlap, with Hover and Capture enabled.

GRID

- **Angle** – Adjust the angle of the survey grid lines.
- **Turnaround Distance** – Sets the distance outside the survey for the H520 to turnaround.
- **Entry** – Selects the mission beginning/data capturing point (Position x where x corresponds to the Survey waypoint number) of the survey. For best battery life, set this value to the nearest entry point from launch point.
- **Refly at 90 Degree Offset** – Overlays a secondary survey grid 90 degrees from the first survey (also known as cross-hatch). This feature is useful for extremely high quality maps, and for flying in early morning or late afternoon flights where long shadows may provide deep contrasts.
- **Altitude** – Sets the survey grid altitude. This is not changeable mid-flight. Use the Waypoint tool when variable altitudes are required.
- **Ground Res** – Sets the ground resolution in inches/pixel, which will automatically calculate and set the survey altitude.

Note: A higher ground resolution requires a lower flight altitude. If unsure about ground resolution altitude, enter desired ground resolution then view the corresponding altitude in the altitude setting (greyed out), and vice versa.

SURVEY INFORMATION

Located at the bottom of the Survey Grid menu, the Statistics area displays general survey information.

- **Survey Area** – Total area covered for current survey grid.
- **Photo Count** – The number of images that will be captured during the mission.
- **Photo Interval** – Current time delay between photos (based on flight speed and ground resolution)
- **Trigger Distance** – The distance between captured images. Review this distance to ensure desired overlap is sufficient.

COMBINING MISSIONS

Surveys and Waypoint flights may be combined in one mission, removing the requirement that the aircraft land and be re-set for oblique flights.

Surveys require “nadir” or downward-facing camera angles. This is ideal for creating an orthomap, and provides an identical angle for all images. In some instances, this is all that is needed to create a rudimentary 3D map. However, 3D mapping is best achieved through a combination of nadir and “oblique” photos (photos taken at a slanted angle to the subject). Oblique images provide for better side skinning when creating 3D models.

After creating the Survey mission, tap the Waypoint icon and insert the first waypoint. Camera yaw should be adjusted to face the subject, and camera angle should be slanted. 45° is a common angle; distance from the object will determine the camera angle. Adding a waypoint mission that is very close to the subject will create challenges in the 3D stitching process; we recommend a distance similar to the altitude of the Survey portion of the capture, when possible. Always check the flight area for obstacles when creating Waypoints in a mission. Maps may not always be up to date.

ADJUSTING WAYPOINTS

Waypoints may be deleted, modified, or edited for position in the Waypoint properties dialog. At the top of each waypoint is a three-line soft button. Tapping this button opens up several options for waypoint management.

In the submenu that opens, users may:

- Insert a new waypoint
- Insert a Survey
- Delete the waypoint
- Edit the Position of the waypoint

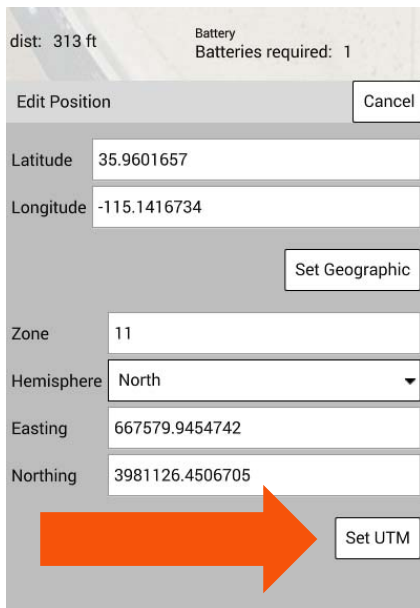
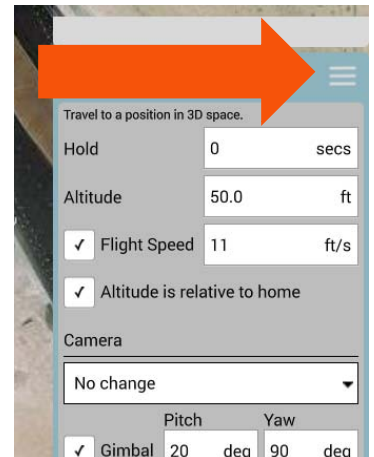

Editing the position of a waypoint may be achieved through manually moving the waypoint via the touchscreen and dragging the waypoint. Precision points may be set via GPS coordinates, or by inserting Universal Transverse Mercator (UTM) points. These are tools used by inspectors and GIS surveyors, yet also offer precision-uses for other data-capture requirements.

Input the required GPS (Latitude/Longitude) value and press the “Set Geographic” soft button.

If UTM coordinates are to be used, set the correct Easting/Northing (assuming Northern Hemisphere) and press the “Set UTM” soft button. Users in the Southern Hemisphere will want to set the Hemisphere value to Southern. The Zone setting for both Northern and Southern Hemispheres is typically determined from map/GPS location.

LAUNCHING A MISSION

After successfully uploading the mission from the mission planning view to the H520, tap the Y icon on the top left of the ST16S. This will return to the DataPilot™ home display screen. To begin a mission, swipe the 'Slide to Confirm' slider from left to right.

WARNING

Ensure the launch area is clear of personnel, equipment and obstacles prior to sliding the start button.

- Aircraft goes straight up from Home position to the altitude specified in the Takeoff waypoint.
- Aircraft then travels at that altitude to the location of the Takeoff waypoint.
- Aircraft then proceeds with the mission.

Note: If the slider is not present on the DataPilot™ Home screen, tap the 'Action' button on the Fly panel, then tap 'Start Mission'.

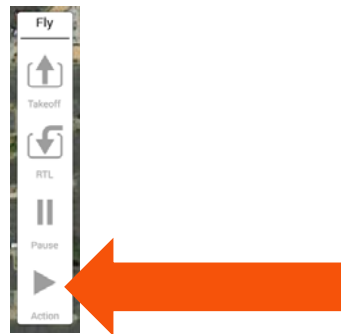

SYNC MISSIONS WITH AIRCRAFT

- **Upload** - Upload the current planned mission from the ST16S to the H520.
- **Download** - Download the current mission from the H520 to the ST16.
- **Save to File** - Save the current planned mission to a file on the ST16S.
- **Load from File** - Loads a saved mission from the ST16S to the mission planning view.
- **Remove All** - Remove the current mission from the mission planning view and from the H520. If the mission is not to be re-flown, it is recommended that missions always be removed from aircraft following a successful flight.

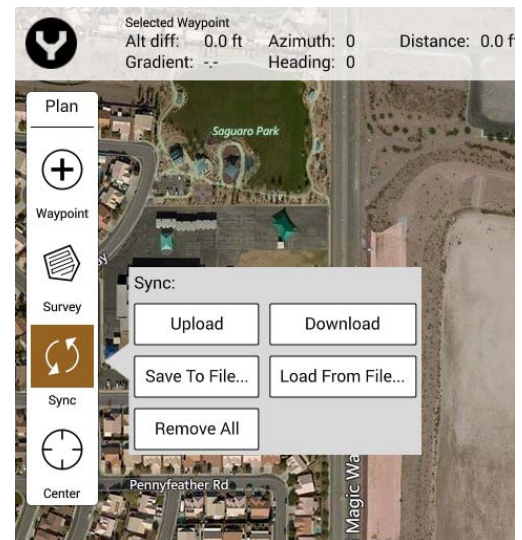

CENTER

- **Mission** – Center the map on the center of the current mission area.
- **All Items** – Centers the map on the center of all mission items.
- **Home** – Centers the map on the current set home location from the H520.
- **Current Location** – Centers the map on the current location of the ST16S. Disabled if no GPS signal is available on the ST16S.
- **Aircraft** – Centers the map on the current location of the H520. Disabled if no GPS signal is available on the H520.

MISSION INFO BAR

The mission status bar is located on top of the mission planning view.

	Selected Waypoint		Total Mission		Battery		Upload Required
	Alt diff: 82.0 ft	Azimuth: 84	Distance: 120.2 ft	Distance: 1789 ft	Max telem dist: 759 ft	Batteries required: 1	
	Gradient: 60 %	Heading: 142		Time: 00:01:57		Swap waypoint: 0	

SELECTED WAYPOINT

- **Alt Diff** – Difference in altitude between current waypoint and previous waypoint.
- **Azimuth** – Compass heading to previous waypoint from current waypoint.
- **Heading** – Compass heading from current waypoint to next waypoint.
- **Gradient** – % change in absolute altitudes from previous waypoint to current waypoint.
- **Distance** – Distance from previous waypoint to current waypoint.

	Selected Waypoint		Total Mission		Battery		Upload Required
	Alt diff: 82.0 ft	Azimuth: 84	Distance: 120.2 ft	Distance: 1789 ft	Max telem dist: 759 ft	Batteries required: 1	
	Gradient: 60 %	Heading: 142		Time: 00:01:57		Swap waypoint: 0	

Plan	+	Waypoint	Survey	Sync	Center
------	---	----------	--------	------	--------

1	Takeoff	Take off from the ground and travel towards the specified position.	Altitude: 82.0 ft	<input checked="" type="checkbox"/> Altitude is relative to home
2	Waypoint			
3	Waypoint			
4	Waypoint			
5	Waypoint			
6	Waypoint			
7	Waypoint			
8	Waypoint			

TOTAL MISSION

- **Distance** – Total distance to be traveled during current mission.
- **Time** – Estimated time required to complete current mission.
- **Max Telemetry Dist** – Maximum distance between H520 and ST16S during current mission.

BATTERY

Batteries Required – Estimated number of batteries required to complete current mission.

Swap Waypoint – Predetermined waypoint for H520 to RTL for battery swap.

UPLOAD REQUIRED/UPLOAD

Soft key required to upload the current planned mission from the ST16S to the H520. When the **Upload Required** soft key is flashing, this indicates the missions are out of sync, and a new upload is required to sync the mission to the H520 prior to mission start.

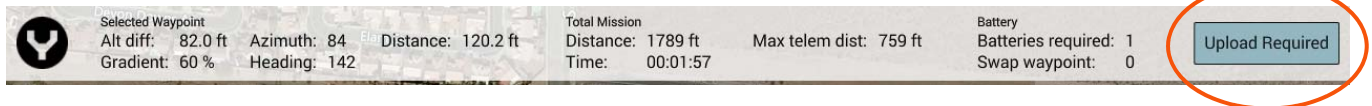

After tapping this button, a thin green progress bar should appear just below the Mission Info Bar, and hear a successful chime from the H520 when the upload is complete. Once the H520 has received the current planned mission, the **Upload Required** will change to Upload.

Note: If the error message '*Error during Mission communication with Aircraft: Aircraft did not request all items from ground station: MISSION_REQUEST*', is received, try the upload again. This typically means that something interfered with the transfer. If the mission repeatedly fails to upload, move the aircraft and ST16S to a different location to avoid transmission interference.

VIEWING A MISSION ON THE ST16S

To view the current mission while the H520 is flying, return to the DataPilot™ home screen by tapping the Y icon. Tap the map rectangle in the lower left corner to switch to the map view. The map view shows the planned mission with the current location of the H520 overlaid on a map. The Pilot can follow and track the status of the mission in this view, as well as see camera indicators where images are being captured.

To switch back to the camera view, tap on the rectangle on the lower left corner. This view displays the live video feed from the camera and enables the Pilot to observe the surroundings from the perspective of the camera.

INTERRUPTING A MISSION

To interrupt a mission in progress, move any of the control sticks on the ST16S, this will give the Pilot immediate control of the H520.

To auto-return to the home/launch position, flip the switch S4 on the ST16S from Angle flight mode (middle position) to RTL mode (bottom position). Return to home may also be executed by selecting the RTL mode from the mode menu in the top center. Select manual mode (top position of S4) if manual control of the aircraft is preferred. During the mission, gimbal settings may be adjusted at any time via the gimbal control switches and dials on the ST16S.

If an RTL is triggered during a leg (between two waypoints), the default resume mission action will re-start from the current waypoint and not the destination waypoint. If the Pilot wants to resume from the next waypoint or another waypoint, he must specifically select that waypoint.

PAUSING A MISSION

The Pilot may want to pause a mission to avoid obstacles or regain his bearings. To pause a mission, tap on the Pause button in the Fly panel. This will cause the H520 to hover and maintain its position. This feature is useful when needing to

RESUMING A MISSION

To resume an interrupted mission, slide the 'Resume Mission' slider on the bottom of the DataPilot™ home screen. If the slider is not present or if the dialog box has been closed, tap the Action button on the Fly menu and select 'Resume Mission'.

The first 'Resume Mission' confirmation rebuilds and uploads the updated mission plan to the aircraft. If the upload times out due to an error, the Pilot can swipe to try the upload again. Once the new mission is successfully uploaded, the user must confirm another 'Resume Mission' dialog to takeoff and re-start/resume the mission.

Note: The aircraft must acquire a GPS lock before it can resume a mission. If the user swipes the second 'Resume Mission' confirmation without GPS ready, the system will display a "Unable to start mission: Aircraft not ready" error. In this scenario, the 'Resume Mission' dialog will be hidden. To resume the mission, tap on the Action button and select 'Start Mission'. Because the new mission has already been uploaded to the aircraft, 'Start Mission' will resume the correct mission.

BATTERY CHANGES DURING MISSION

If a battery change is required during a planned mission, the H520 will automatically execute a RTL and land. Once the H520 has landed, remove the depleted battery and replace with a charged battery. Wait for the H520 to establish a connection with the ST16S and GPS lock.

Note: The aircraft may take up to two minutes to reconnect.

Once both signals have been locked, a '**Resume Mission**' slider will appear on the bottom of the Fly view. Slide the arrow to confirm resuming the mission. Ensure the launch area is clear of personnel, equipment and obstacles, prior to sliding the '**Resume Mission**' slider.

ENDING A MISSION

Once the H520 has landed after completing a mission, a pop-up window will appear on the right side of the DataPilot™ Home Screen. This window will ask if the Pilot would like to leave the mission on the H520 or remove the mission from the H520. Selecting to remove the mission will delete the current mission from the aircraft's memory. Uploading a new mission will overwrite the current mission on the H520.

REFLY A MISSION

After completing a mission, if the mission requires re-flight, tap on the first waypoint (to reset the current mission item), and then tap **'Start Mission'** under the Action button menu. The mission will begin again from the beginning. Similarly, if the Pilot wants to resume the mission from a certain waypoint, he can select that waypoint, and then choose **'Start Mission'** as above.

REMOVING A MISSION

To remove the current mission on the H520, either upload a new mission or select **'Remove All'** from the Sync button in the Plan panel. Turning off the power to the aircraft and restarting will not remove the mission.

GEAR SWITCH

In mission mode, the landing gear will automatically retract after reaching takeoff altitude. After the mission is complete and a RTL is triggered, the landing gear will continue to stay up until it reaches the home position. The landing gear will come down prior to descending from the RTL altitude. To deploy the landing gear after exiting Mission mode, the Pilot may need to cycle (flip up and down) the landing gear switch to activate the switch. However, in Angle and Manual flight mode, the gear switch will respond correctly to the selected position.

Note: During RTL after mission complete, the Pilot may need to cycle (flip up and down) the landing gear switch twice to bring down the landing gear.

FLIGHT MODES

NOT CONNECTED FLIGHT MODE

Not Connected Flight mode is set when there is no aircraft bound to DataPilot™. A valid RC connection is required for a flight mode to be present.

AUTO-POSITION FLIGHT MODE

Auto-Position Flight mode is automatically set when the aircraft is flying autonomously but has no commands to execute. In this case, the H520 will hold its current position and hover in place.

MANUAL FLIGHT MODE

Manual Flight mode is selected either by flipping switch S4 to the top position or tapping the flight mode soft key on the DataPilot™ home screen. Manual Flight mode disables all GPS on the H520, however altitude is maintained using barometric sensors. Manual Flight mode enables the Pilot to fly in GPS-denied environments such as indoors or under/around obstacles. Manual Flight mode will not prevent drifting during maneuvers, hence the Pilot is required to apply opposite stick input to stop drift. Manual flight Mode is indicated on the H520 by the yellow LEDs on the two rear motor arms.

ANGLE FLIGHT MODE

Angle Flight mode is selected by centering switch S4 or by tapping the flight mode soft key on the DataPilot™ home screen. Angle Flight mode incorporates GPS, barometric and other sensors to maintain stable position in-flight. Angle Flight mode is indicated on the H520 by the purple LEDs on the two rear motor arms.

MISSION FLIGHT MODE

Mission Flight mode is the mission execution mode. After uploading and starting a mission, the H520 will automatically be set to Mission flight mode. Mission Flight mode is indicated on the H520 by the blue LEDs on the two rear motor arms.

RETURN TO LAUNCH (RTL) FLIGHT MODE

Return to Launch flight mode is selected by placing switch S4 in the full down position or by tapping the RTL soft key on the ST16S Fly panel. Return to Launch Flight mode is an automatic execution of the H520 to return to the launch point. During RTL, the Pilot has limited control over the H520. RTL Flight mode is indicated by flashing blue LEDs on the two rear motor arms.

LOW BATTERY FLIGHT MODE

During low battery flight mode, the H520 will attempt to RTL. In some cases, the H520 might be too far from the launch site to return. During low battery flight mode, the Pilot has limited lateral control and no vertical control of the H520. Low battery flight mode is indicated by flashing red LEDs on the two rear motor arms.

USING DATAPILOT™ ON A DESKTOP/LAPTOP COMPUTER

DataPilot™ functions on a desktop or laptop computer, without requiring an aircraft to be connected. The application does not have the ability to launch nor control flight; it has been created for creating and exporting missions in a remote environment. The application is useful in organizations where missions are planned away from a mission location, where mission planners may not be piloting the H520 aircraft, or missions are to be programmed in an office environment. Any mission programmed in the desktop application may be transferred to the ST16S via remote connection, thumbdrive, MicroSD card, or by emailing the ST16S directly from the desktop.

The Yuneec DataPilot application may be installed on either Apple or Windows systems.

After installing the application, an icon will be found on the desktop.



Double-click the icon to open the desktop planning application.

The application is similar in appearance to the ST16S version of DataPilot™ with minor differences. Note that there is no Video window, and no vehicle connection nor General Menu screen.

Missions may be planned with greater efficiency, and shared with the pilot, stored for recall during recurring projects, archived for project management, or for legal purposes. For example, a Public Safety Organization may choose to plan an accident scene scan from inside a patrol car, vs working with the smaller screen of the ST16S, or perhaps the flight plan requires saving into a flight log/fleet management system. DataPilot Planner is designed for off-site or detailed planning of missions.

Logs may also be downloaded directly from the aircraft or ST16S using the DataPilot™ Planner application.



Mission preferences are set in the General Menu settings. Access the General Menu by clicking on the icon.

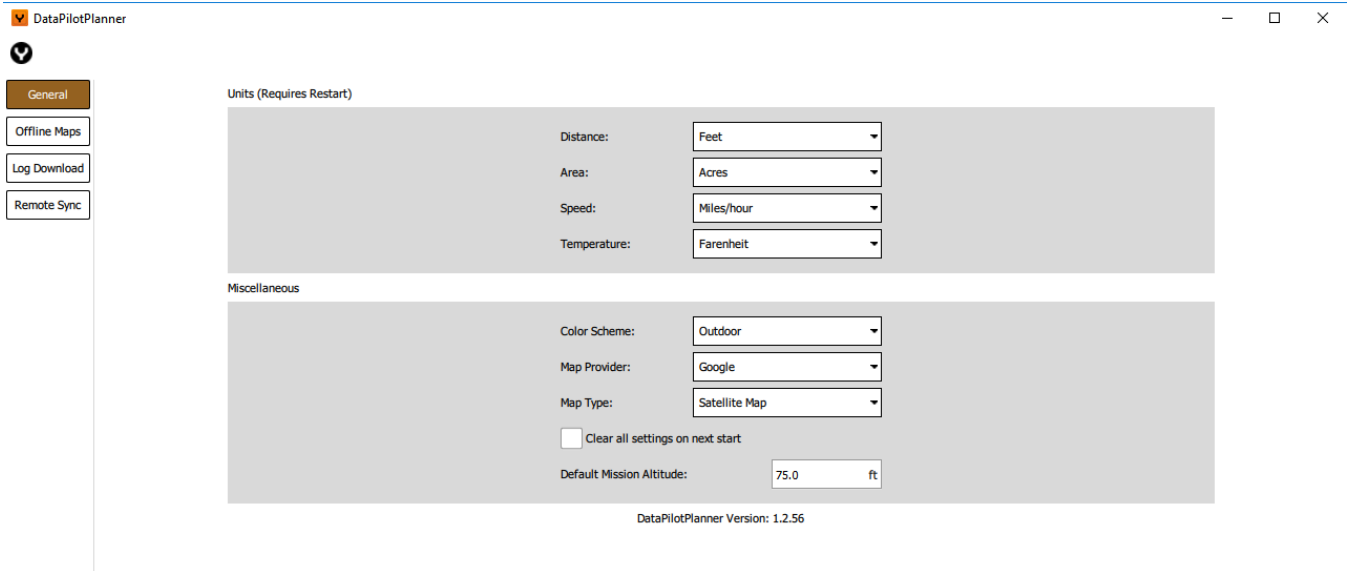

In the General Menu, preferred Units are set (Requires restart of the application after settings are selected). In this menu, Distance units (feet/meters), Area (Square Miles, Square Feet, Square Kilometers, Hectares, Acres), Speed (Miles/hour, Meters per Second, Feet Per Second, Kilometers per Hour, Knots), the Color Scheme (Outdoor/Indoor), Map Provider (Google, Esri, Bing, Statkart), and Map Type (Satellite, Street, Terrain) may be selected. A default mission altitude may be set.

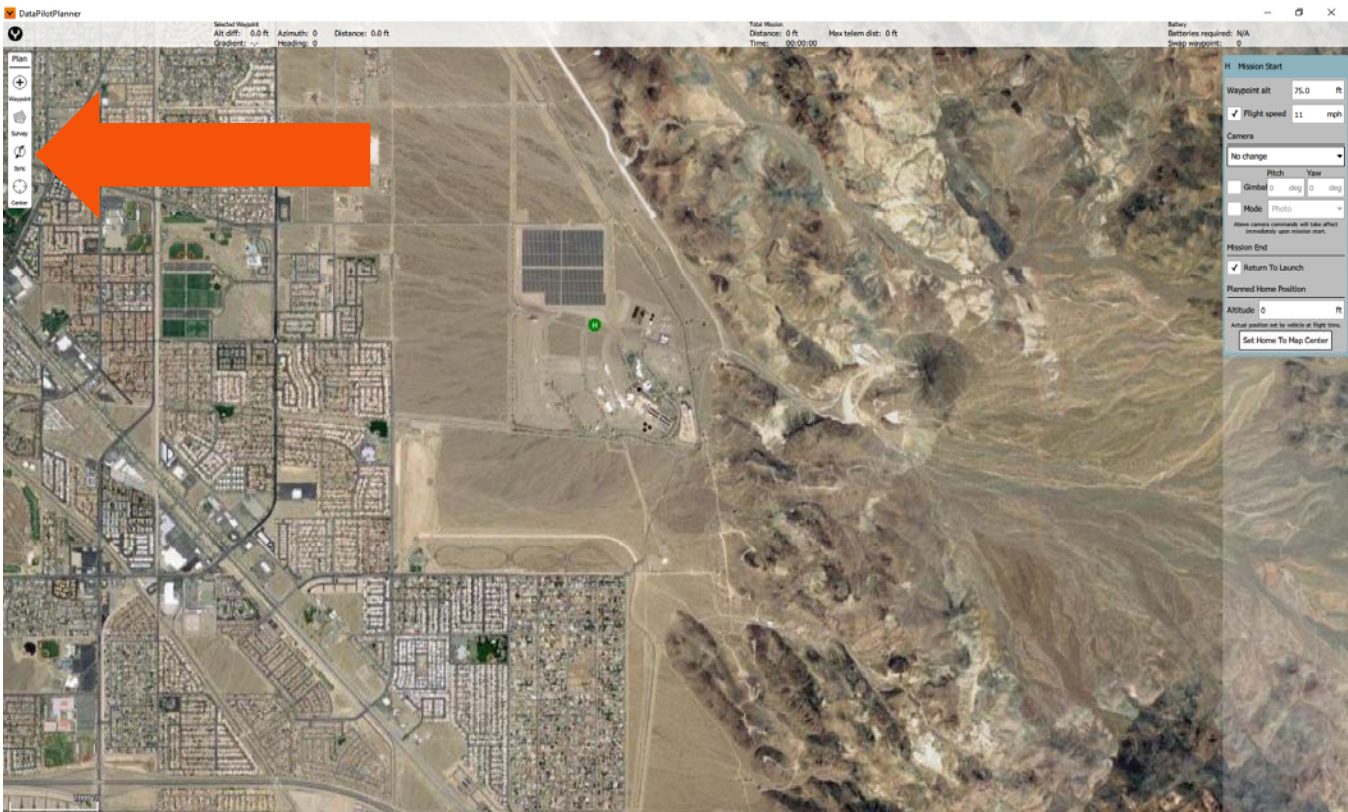

Create a mission and click on SYNC | SAVE TO FILE. Store the mission on a MicroSD card, or email the file to an email account that may be accessed on the ST16S.

Open DataPilot™ and tap the PLAN view icon to open the Mission Planning interface. Tap SYNC | LOAD FROM FILE and browse to either the MicroSD card, or to a file location where an emailed file has been received/stored.

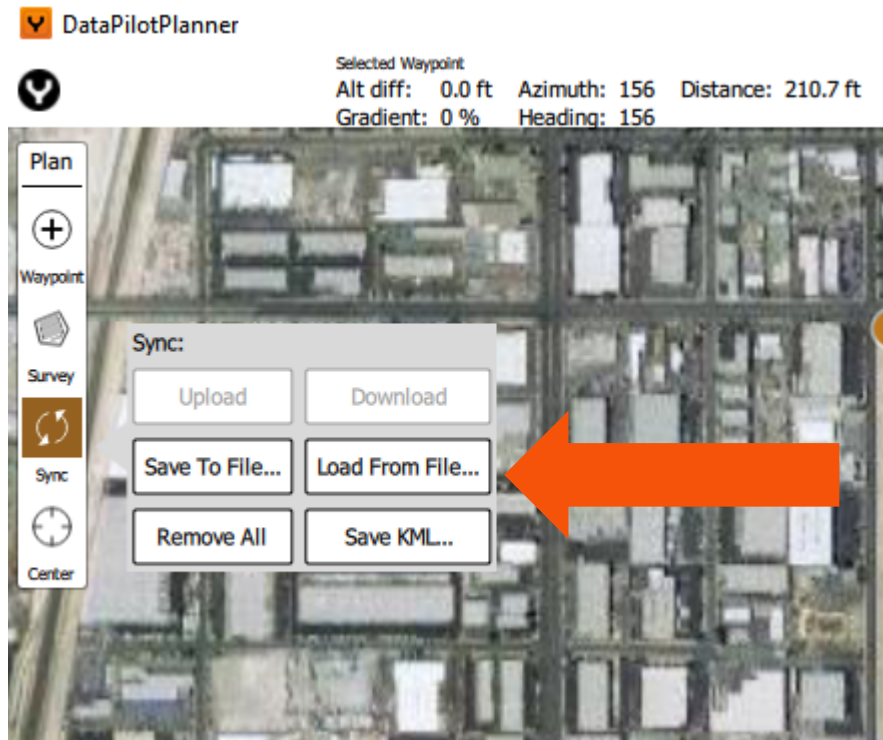

Load the .plan mission file and execute the desktop-planned mission.

Following the mission execution, .plan files may be stored with images from the mapping mission for project management purposes. Use the “Export Mission” feature found in DataPilot™ to export the mission to a MicroSD card that may be copied to a storage device, or email the .plan file to a desktop, Project Manager, IT department, etc.

REMOTE TRANSFER

Missions may be transferred to/from the ST16S and the desktop computer. Connect the ST16S to the same network as the desktop computer. Launch DataPilot™ and in the DataPilot™Planner application, open the remote connection by first tapping the  soft button in the upper left corner of the screen. The Remote connection dialog will open.

Choose the appropriate ST16S and select “connect.” The ST16S and the DataPilot™ Planner application will sync and prepare for bi-directional file transfer.

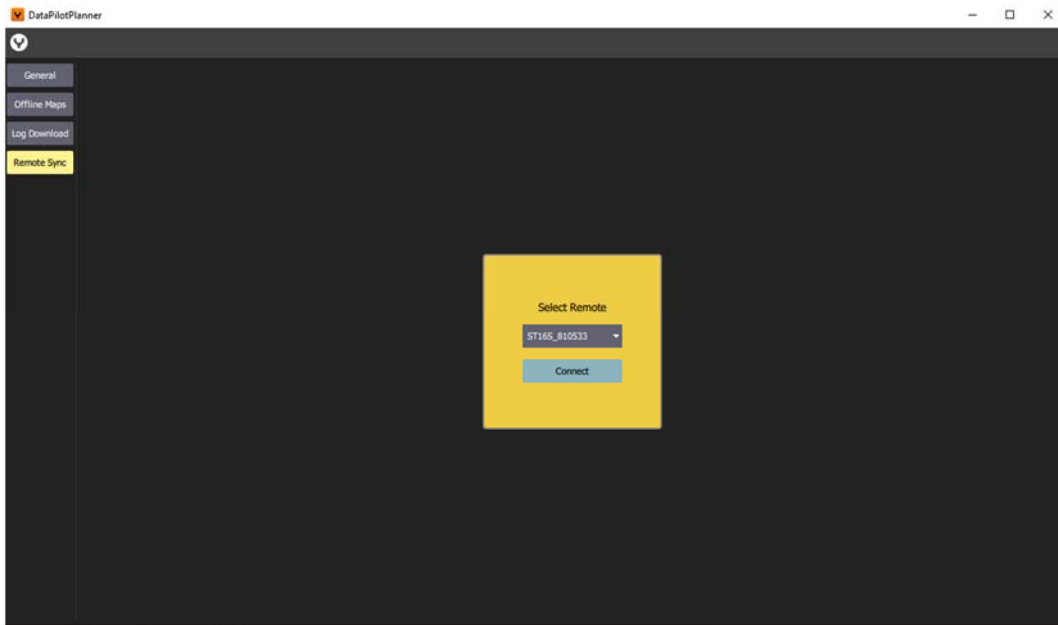

The ST16S will display a window, demonstrating the connection and that DataPilot™ on the ST16S is not accessible during remote connection sessions.

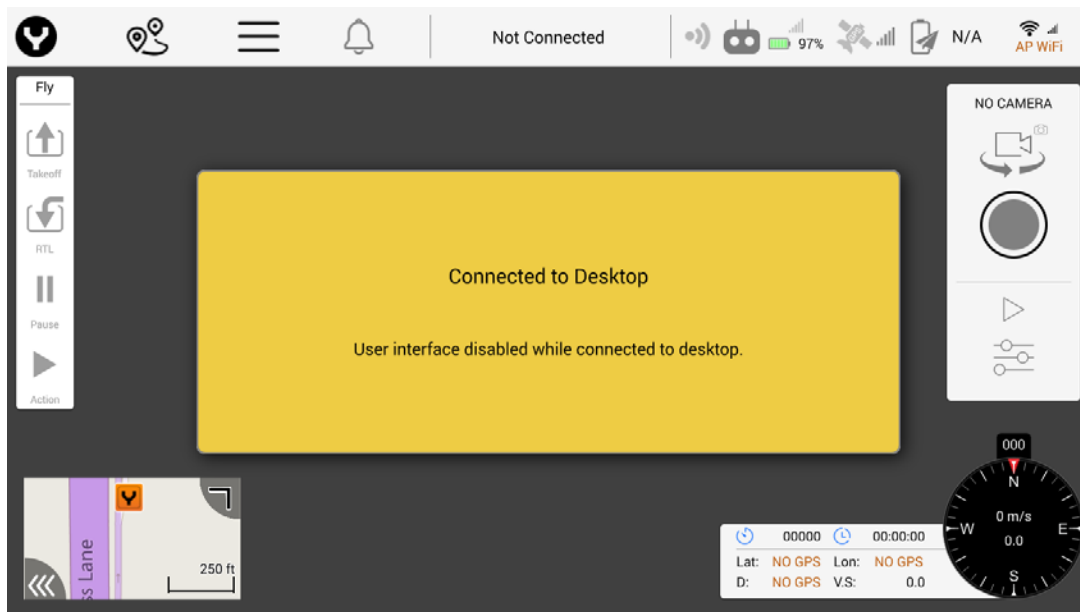

DataPilot™ Planner will then offer options for data transfer.

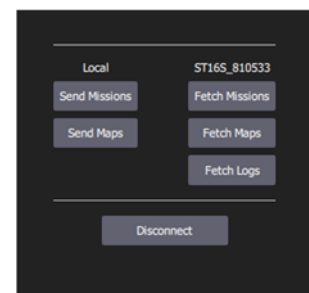

If missions planned on the DataPilot™ Planner are to be transferred to the ST16S, choose “Send Missions” in the Local dialog. This will open a file chooser where a mission plan may be selected and transferred directly to the ST16S for upload to the H520 aircraft.

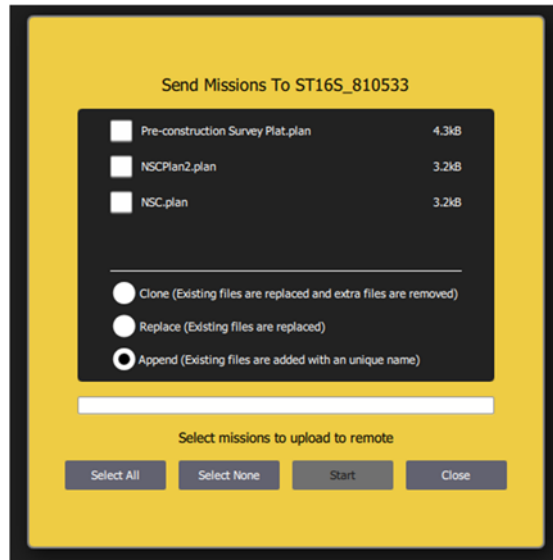

Choose a mission(s) to be transferred and select “Start.” The mission(s) will be transferred to the ST16S. These files may be accessed through “load mission” on the ST16S Sync dialog once the files have been successfully transferred.

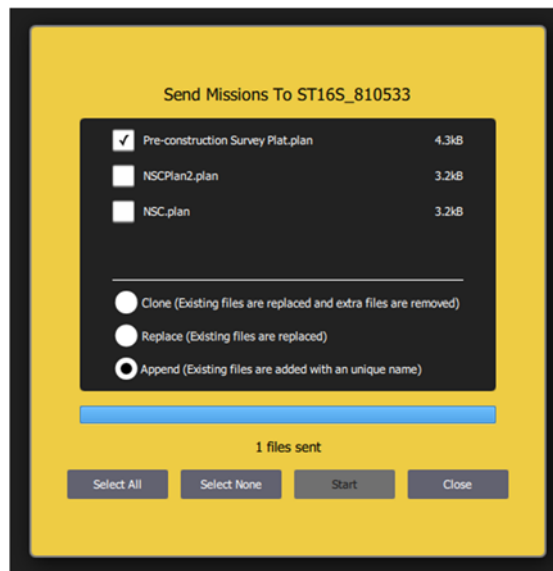

Successful transfers will be indicated the Send Missions dialog.

Close the connection by choosing “Close” and then “Disconnect” from the dialog.

TELEMETRY FILES

Telemetry files (tlogs) may be downloaded from the ST16S using the DataPilot™ Planner application.

Choose “Fetch Logs” from the Remote Sync Menu, and a file chooser will open.

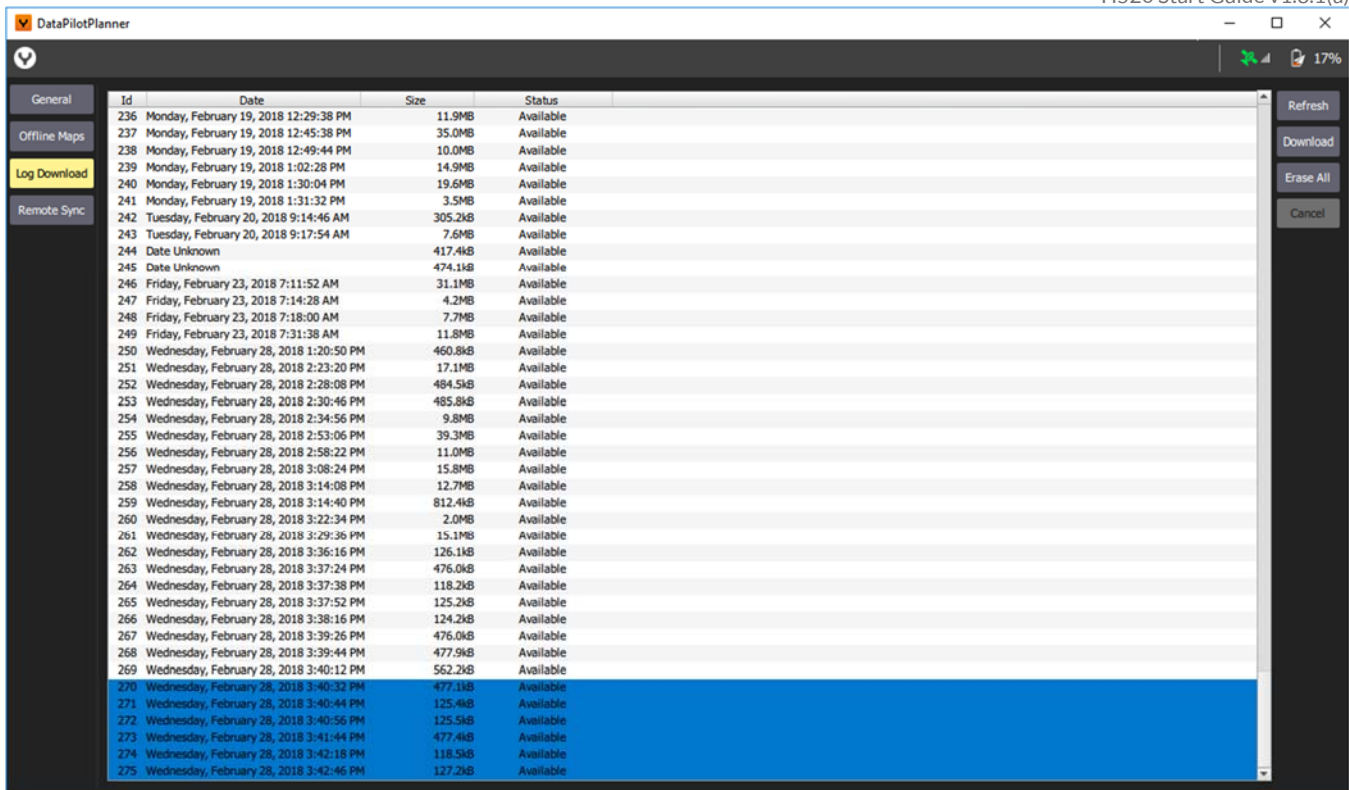

Multiple files may be selected for download. These files may be used for examining issues during flight, technical support, or archived along with other flight-related files such as vehicle logs, missions, and data captured during a specific flight.

Logs may also be deleted in this window, enabling users to free up space on the ST16S.

VEHICLE LOGS

Aircraft/Vehicle logs may also be downloaded by connecting the H520 via USB to the computer.

Select “Refresh” from the Log Download menu, and the aircraft log file chooser will open. Missions may be downloaded here. Memory-dependent, some computer systems may not allow for all logs to be downloaded at once. If the application is unable to download all files at once, download files in groups of 4-5 files per download for best results.

With DataPilot™ Planner open, connect the aircraft to the computer via USB.

A green line will show connection progress across the top of the GUI. Once the connection is complete, logs may be downloaded from the H520 aircraft.

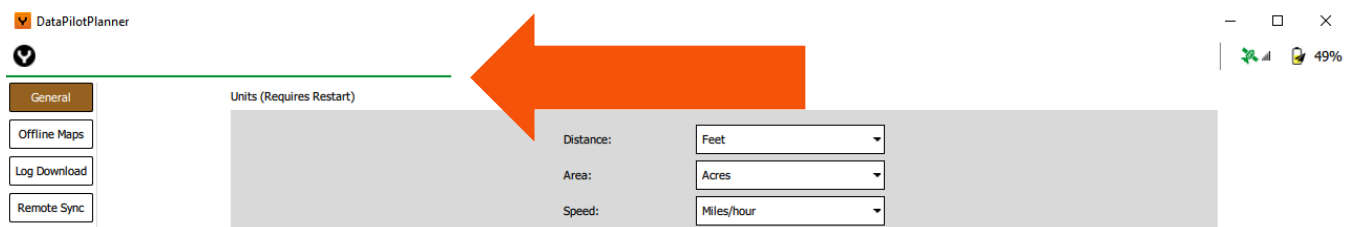

Select the “Log Download” button on the left side of the DataPilot™ Planner interface and the logfile chooser will open.

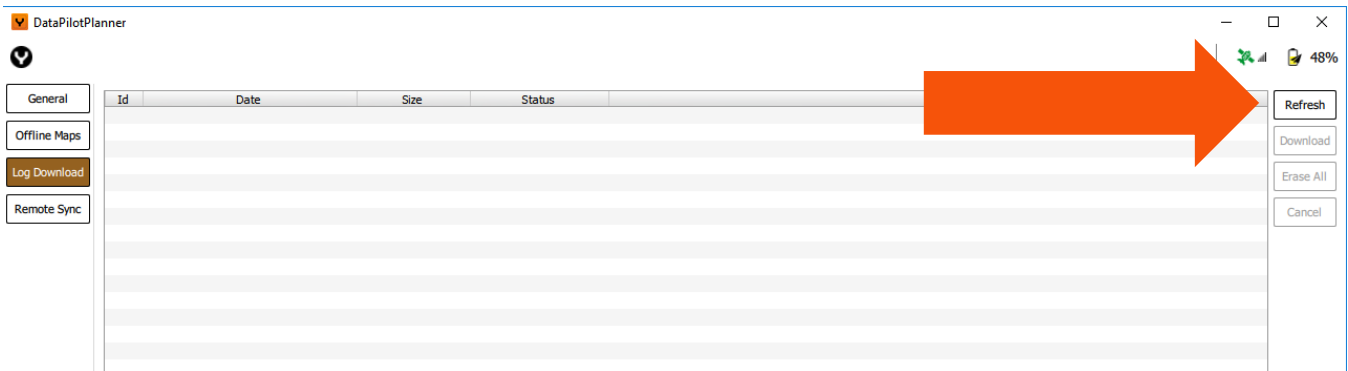

If no logs are shown, select the “Refresh” button on the right side of the chooser. This will refresh the view, and all logs on the aircraft will be visible and available for download. If the aircraft has flown many times, there may be quite a few logs and may take a few minutes to fully populate the chooser.

Select desired logs for download and select the “Download” button on the right side of the chooser.

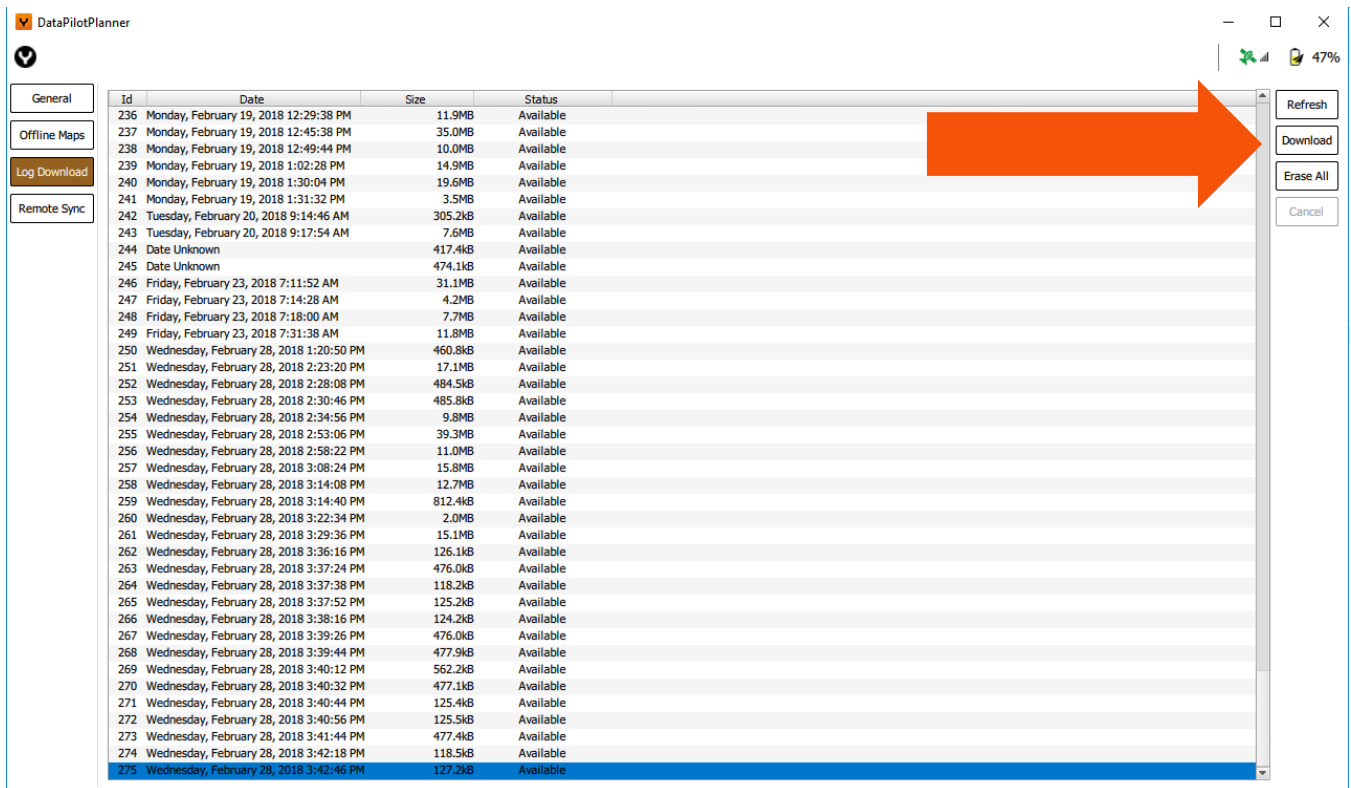

As with Tlogs, some computer systems may not be able to download large multiples of files at once. If this occurs, select 5-6 files at a time for download.

Log files on the aircraft may be erased at any time.



Please contact your local dealer for updated information regarding this H520 aircraft, DataPilot™, DataPilot™ Planner, UpdaterPilot™ or the ST16S Ground Station Control.

Yuneec Americas (USA)

2275 Sampson Ste 200
Corona,
CA 91764
USA

Support: 844 898 6332
Sales: 844 343 9966

Email: uscs@yuneec.com

Yuneec Europe (GmbH)

Nikolaus-Otto-Strasse 4
24568 Kaltenkirchen

Germany

Support Hotline Germany:
+49 4191 932620

Email: eucs@yuneec.com

Yuneec Asia (HK)

2/F, Man Shung Industrial
Building

7 Lai Yip Street

Kwun Tong

Hong Kong

Main Line: +852 3616-6071

Email: hkcs@yuneec.com

Yuneec 中国 (上海)

徐汇区虹漕路461号漕河

泾软件大厦B座15楼

热线电话:

+86 400 8207 506

Email: saleschina@yuneec.com